

FusionServer X6000 Server

Technical White Paper

Issue 04
Date 2023-11-30

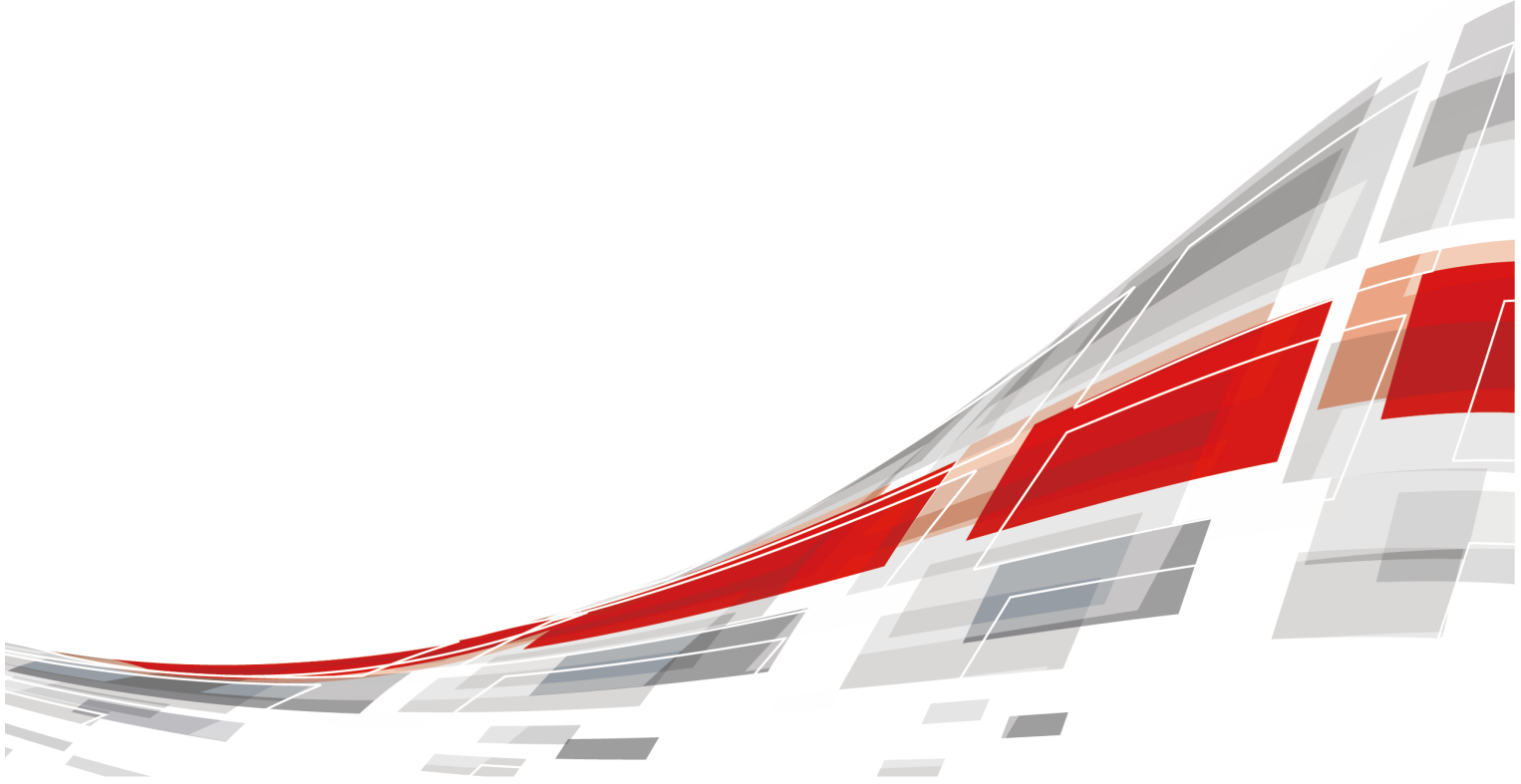

Copyright © xFusion Digital Technologies Co., Ltd. 2023. All rights reserved.

No part of this document may be reproduced or transmitted in any form or by any means without prior written consent of xFusion Digital Technologies Co., Ltd.

Trademarks and Permissions

XFUSION and other xFusion trademarks are trademarks of xFusion Digital Technologies Co., Ltd. All other trademarks and trade names mentioned in this document are the property of their respective holders.

Notice

In this document, "xFusion" is used to refer to "xFusion Digital Technologies Co., Ltd." for concise description and easy understanding, which does not mean that "xFusion" may have any other meaning. Any "xFusion" mentioned or described hereof may not be understood as any meaning other than "xFusion Digital Technologies Co., Ltd.", and xFusion Digital Technologies Co., Ltd. shall not bear any liability resulting from the use of "xFusion".

The purchased products, services and features are stipulated by the contract made between xFusion and the customer. All or part of the products, services and features described in this document may not be within the purchase scope or the usage scope. Unless otherwise specified in the contract, all statements, information, and recommendations in this document are provided "AS IS" without warranties, guarantees or representations of any kind, either express or implied.

The information in this document is subject to change without notice. Every effort has been made in the preparation of this document to ensure accuracy of the contents, but all statements, information, and recommendations in this document do not constitute a warranty of any kind, express or implied.

xFusion Digital Technologies Co., Ltd.

Address: 9th Floor, Building 1, Zensun Boya Square, Longzihu Wisdom Island
Zhengdong New District 450046
Zhengzhou, Henan Province
People's Republic of China

Website: <https://www.xfusion.com>

About This Document

Purpose





This document describes the X6000 server in terms of appearance, features, system architecture, components, security management, system management, and technical specifications.

Intended Audience

This document is intended for pre-sales engineers.

Symbol Conventions

The symbols that may be found in this document are defined as follows.

Symbol	Description
	Indicates a hazard with a high level of risk which, if not avoided, will result in death or serious injury.
	Indicates a hazard with a medium level of risk which, if not avoided, could result in death or serious injury.
	Indicates a hazard with a low level of risk which, if not avoided, could result in minor or moderate injury.
	Indicates a potentially hazardous situation which, if not avoided, could result in equipment damage, data loss, performance deterioration, or unanticipated results. NOTICE is used to address practices not related to personal injury.
	Supplements the important information in the main text. NOTE is used to address information not related to personal injury, equipment damage, and environment deterioration.

Change History

Issue	Date	Description
04	2023-11-30	Added 8 Waste Product Recycling .
03	2023-02-28	Updated 1 Product Overview .
02	2022-11-30	This issue is the second official release.
01	2021-11-02	The issue is the first official release.

Contents

About This Document.....	ii
1 Product Overview.....	1
1.1 Overview.....	1
1.2 Features.....	2
2 System Architecture.....	4
2.1 Server Design.....	4
2.2 Cooling Design.....	5
2.3 Management and Monitoring.....	7
2.4 Advantages.....	9
3 Hardware Description.....	10
3.1 Enhanced Chassis.....	10
3.1.1 Appearance.....	10
3.1.2 Structure.....	17
3.1.3 Server Node.....	19
3.1.4 Fan Module.....	20
3.1.5 PSU.....	21
3.1.6 System Backplane and Hard Disk Backplane.....	23
3.1.7 HMM.....	24
3.2 Standard Chassis.....	25
3.2.1 Appearance.....	25
3.2.2 Structure.....	32
3.2.3 Server Node.....	34
3.2.4 Fan Module.....	35
3.2.5 PSU.....	35
3.2.6 System Backplane and Hard Disk Backplane.....	39
3.2.7 HMM.....	40
4 Security Management.....	42
4.1 Server Nodes.....	42
4.2 HMM.....	42
5 System Management Features.....	44
5.1 iBMC Features.....	44

5.2 HMM Features.....	46
5.3 Management Principles.....	47
5.4 Management Mode.....	47
6 Product Specifications.....	50
6.1 Enhanced Chassis.....	50
6.1.1 Chassis Specifications.....	50
6.1.2 Server Node Specifications.....	51
6.1.3 PSU and Power.....	52
6.1.4 Environmental Specifications.....	53
6.2 Standard Chassis.....	62
6.2.1 Chassis Specifications.....	62
6.2.2 Node Specifications.....	64
6.2.3 Power Specifications.....	65
6.2.4 Environmental Specifications.....	66
7 Warranty and Safety.....	72
7.1 Warranty.....	72
7.2 Safety.....	72
8 Waste Product Recycling.....	73
A Appendix.....	74
A.1 Chassis Label.....	74
A.1.1 Chassis Head Label.....	74
A.1.1.1 Product SN.....	75
A.1.1.2 Nameplate.....	76
A.1.1.3 Certificate.....	76
A.1.1.4 Sample Quick Access Tags.....	78
A.1.2 Chassis Tail Label.....	79
A.2 Acronyms and Abbreviations.....	79

1 Product Overview

[1.1 Overview](#)

[1.2 Features](#)

1.1 Overview

The X6000 server is a next-generation 2U high-density server designed for ISP customers inside and outside China, Internet, high-performance computing (HPC), cloud computing, and data center applications. Built on an architecture optimized for software-defined storage (SDS) and Big Data, it is ideal for large-scale server deployment.

The X6000 is a multi-node server that is 2U high. It features high density, reliability, scalability, and energy efficiency, and is easy to manage and maintain.

Market positioning of the X6000 is as follows:

- Provides customized server solutions that offer low power consumption, easy maintenance, and rapid deployment for Internet and data center applications.
- Provides a hardware platform to meet requirements for high reliability and virtualization performance for HPC, cloud computing, and ISP applications.

The X6000 supports a standard chassis or an enhanced chassis.

Standard:

- 24 x 2.5-inch SAS or SATA drives at the front (Chassis BOM: 02301401)
- 24 x 2.5-inch SAS or SATA drives, or NVMe SSDs at the front (Chassis BOM: 02301403)

Enhanced:

- 24 x 2.5-inch SAS or SATA drives at the front (Chassis BOM: 02301459)
- 24 x 2.5-inch SAS or SATA drives, or NVMe SSDs at the front (Chassis BOM: 02301459)
- 12 x 3.5-inch SAS or SATA drives at the front (Chassis BOM: 02301460)

Figure 1-1 and **Figure 1-2** show an X6000 with 2.5-inch hard disks.

Figure 1-1 X6000 server(Standard chassis)

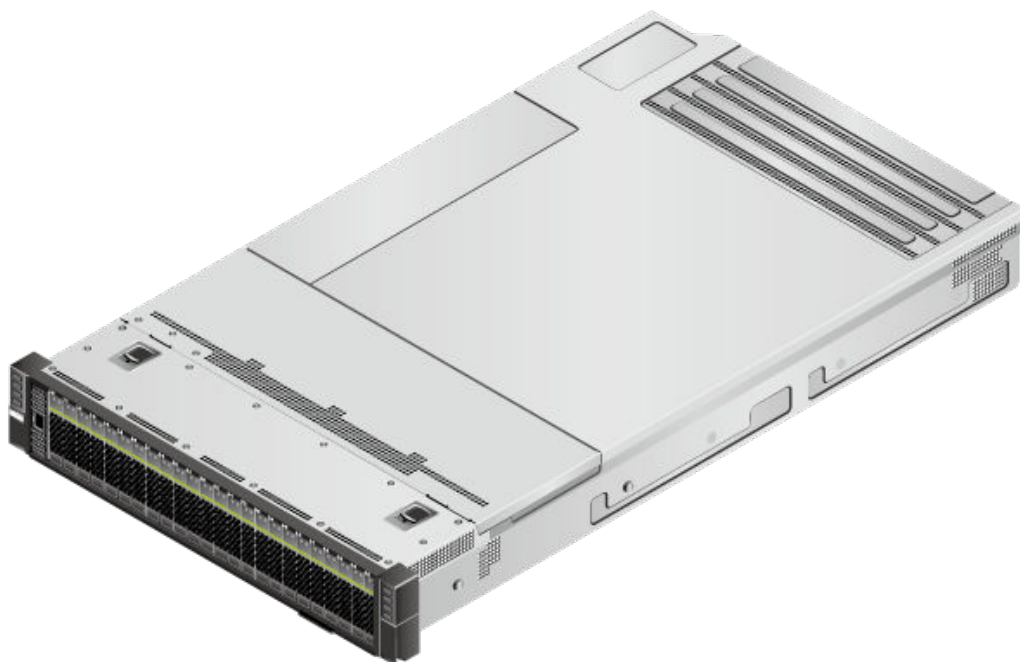
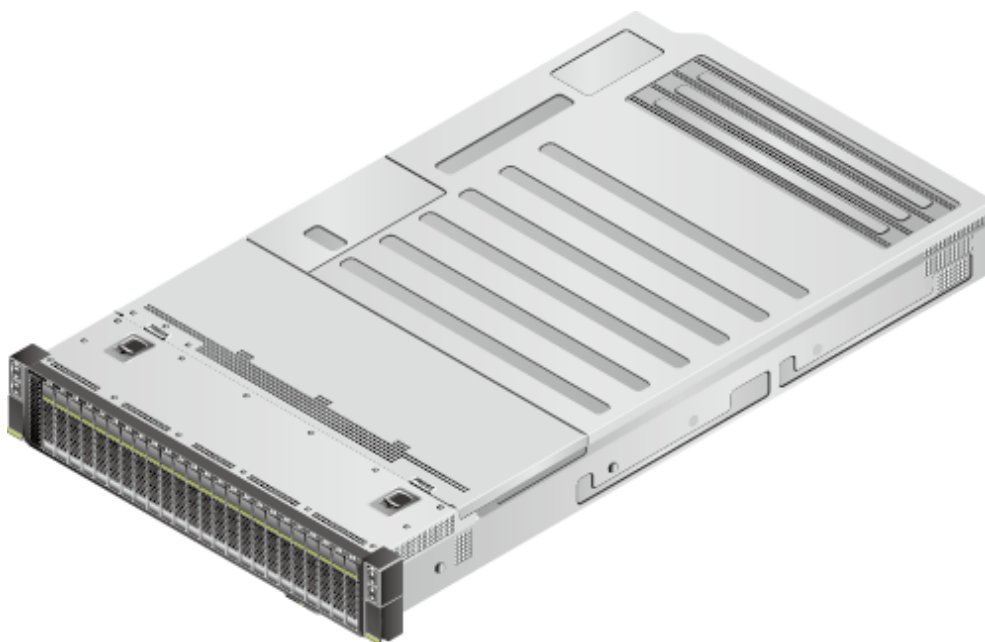

Figure 1-2 X6000 server(Enhanced Chassis)



1.2 Features

- **Ultra-High Density Design Reducing Equipment Footprint**

The X6000 provides higher density than conventional rack servers, reducing the footprint in equipment rooms.

- The X6000 provides computing density twice that of a conventional 1U rack server and four times that of a conventional 2U rack server, greatly improving space utilization in equipment rooms.
- Each node supports six 2.5-inch or three 3.5-inch hard disks.
- **Unified Management and Easy Maintenance**

The X6000 leverages the blade server architecture to provide unified management and easy maintenance.

 - The X6000 uses the iBMC+HMM management. By incorporating advantages of rack and blade servers, the X6000 allows nodes to be installed at the rear and supports rear cabling.
 - The modular design and hot-swappable key components greatly improve O&M efficiency.
- **Shared Architecture and High Energy Efficiency**

All server nodes in an X6000 chassis share power supplies and the heat dissipation system.

 - Server nodes share two PSUs and four fan modules, simplifying deployment and increasing PSU and fan module utilization.
 - The X6000 uses the Dynamic Energy Management Technology (DEMT) to control system energy consumption and increase the energy efficiency.
- **Redundancy Design and High Reliability**

The X6000 adopts a reliable system architecture to ensure stable and long-term operation.

 - The X6000 supports redundant fan modules and PSUs as well as RAID configuration, preventing data loss and service interruption.
 - The X6000 uses carrier-class components and manufacturing processes to improve stability and ensure a longer life cycle.
- **Support for Customization**

Quick customized development and delivery.

2 System Architecture

[2.1 Server Design](#)

[2.2 Cooling Design](#)

[2.3 Management and Monitoring](#)

[2.4 Advantages](#)

2.1 Server Design

The X6000 is a next-generation server that has the following features:

- The server is 2U high and supports four server nodes. Each node supports up to six 2.5–inch hard disks or three 3.5–inch hard disks.
- The server nodes share PSUs, and support PSUs in 1+1 redundancy mode when CPUs of 205 W or lower are used.
- All server nodes in a chassis share fan modules in N+1 redundancy mode.

NOTE

- Server nodes 1 and 2 share fan modules 1 and 2, and server nodes 3 and 4 share fan modules 3 and 4.
- If the server nodes are not in position, the corresponding fan modules rotate at the default speed.
- The server supports rear cabling and network controller sideband interface (NC-SI).
- Standard Chassis: The HMM provides an aggregation network port connected to the rear panel using a port aggregation module. This aggregation network port is connected to the iBMC of the four server nodes using one management network cable, so that only one port for the out-of-band management system is displayed to external entities.
- Enhanced Chassis: The HMM provides an aggregation network port connected to the rear panel using a port aggregation module. This aggregation network port is connected to the iBMC of the four server nodes using one management network cable, so that only one port for the out-of-band management system is displayed to external entities.

[Figure 2-1](#) and [Figure 2-2](#) show the server system architecture.

Figure 2-1 Server system architecture (Standard Chassis)

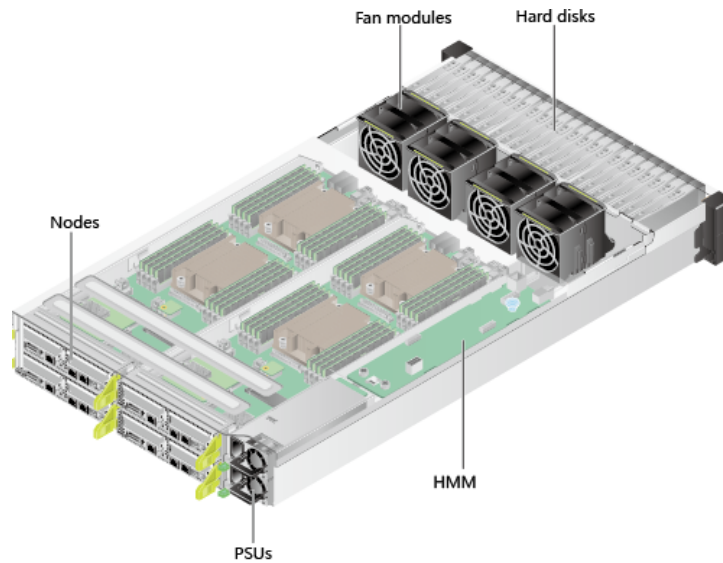
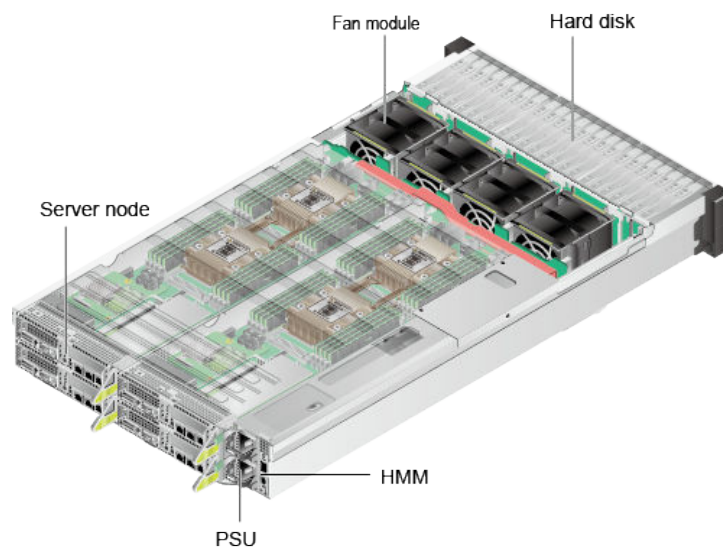

Figure 2-2 Server system architecture (Enhanced Chassis)



2.2 Cooling Design

The X6000 has the following features:

The server draws cool air in from the front of the chassis, delivers the cool air through the hard disks, fan modules, backplane to the four server nodes, and then to the processors and dual in-line memory modules (DIMMs), and then exhausts air from the rear of the chassis. There are air vents on the top, bottom, and side panels of the server to facilitate heat dissipation.

Figure 2-3 X6000 enhanced chassis air flow (top view)

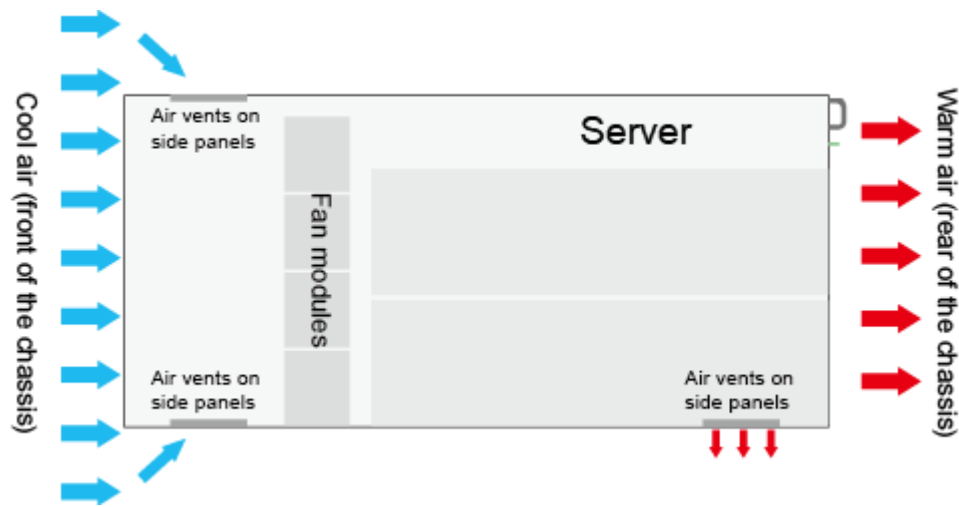
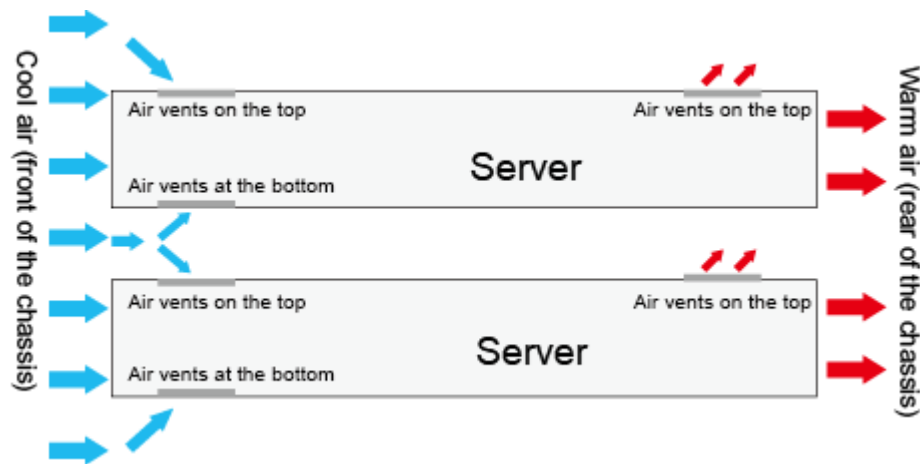

Figure 2-4 X6000 enhanced chassis air flow (side view)



NOTICE

- Ensure that heat is dissipated from the cabinet in time. Heat accumulation and air reflow affect the heat dissipation of the server.
- Do not block air vents to prevent device damage due to poor heat dissipation.

The heat dissipation design of the X6000 chassis features the following:

- The X6000 uses four 8080 counter rotating fans with high wind pressure to provide industry-leading cooling and power-saving capabilities.
- The 8080 fans use DTS 2.0 control to ensure low power consumption.
- The X6000 minimizes noise through speed adjustment, shock absorption, and noise isolation design.
- The high-pressure counter-rotating fans provide a 10% more air volume than normal fans. The refined air channels implement concentrated cooling of heat-sensitive devices. Temperature sensors are distributed to cover all areas of heat concentration, facilitating accurate fan speed adjustment. The cellular panel

allows a 10% more air volume than square holes. The PID algorithm for speed adjustment ensures long-term stable system running at 35°C (95°F).

2.3 Management and Monitoring

- The system adopts an iBMC+HMM two-layer management architecture. The iBMC manages each node over the Intelligent Platform Management Interface (IPMI), keyboard, video, and mouse (KVM), or virtual DVD-ROM drive. The HMM implements the chassis management, which includes management for fan modules, PSUs, and chassis assets. The node panel provides GE management ports for customers to manage nodes, chassis, and models.
- The chassis provides a GE aggregation port for customers to visit HMM and iBMC modules and manage the chassis and nodes.
- The HMM and fan control board (FBC) implement fan module monitoring and management. The FBC provides four independent pulse-width modulation (PWM) control signals for adjusting the fan speed and eight TACH signals for detecting the fan speed.

The HMM and iBMC determine a proper speed based on speed adjustment algorithms and deliver the speed to the fan board to control the fan speed. The fan backplane detects the operating status of the fan modules through the rotation speed feedback signals, and reports to the HMM for the fan module health management.

- PSU monitoring and management: The HMM provides an inter-integrated circuit (I2C) for managing the PSUs and general purpose input/output (GPIO) pins for detecting the PSU installation status and PWROK state. The HMM supports queries on PSU input power, PSU installation status, and PSU alarms. [Figure 2-5](#) and [Figure 2-6](#) show the X6000 management and monitoring design.

Figure 2-5 X6000 monitoring and management design (Standard Chassis)

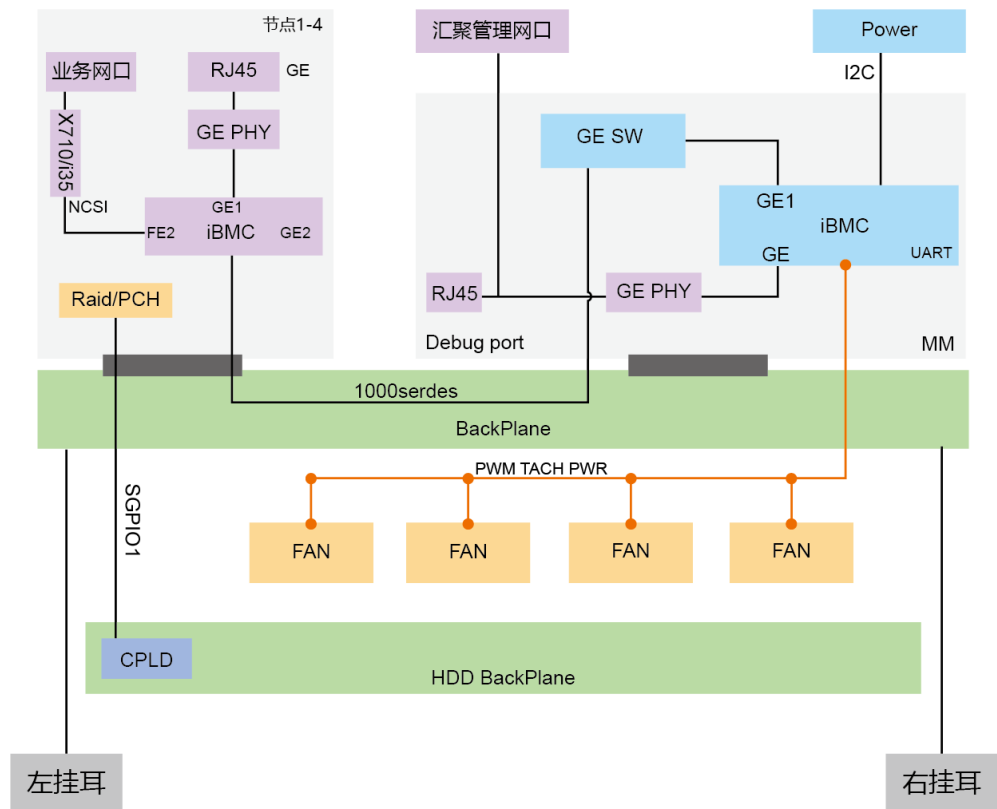
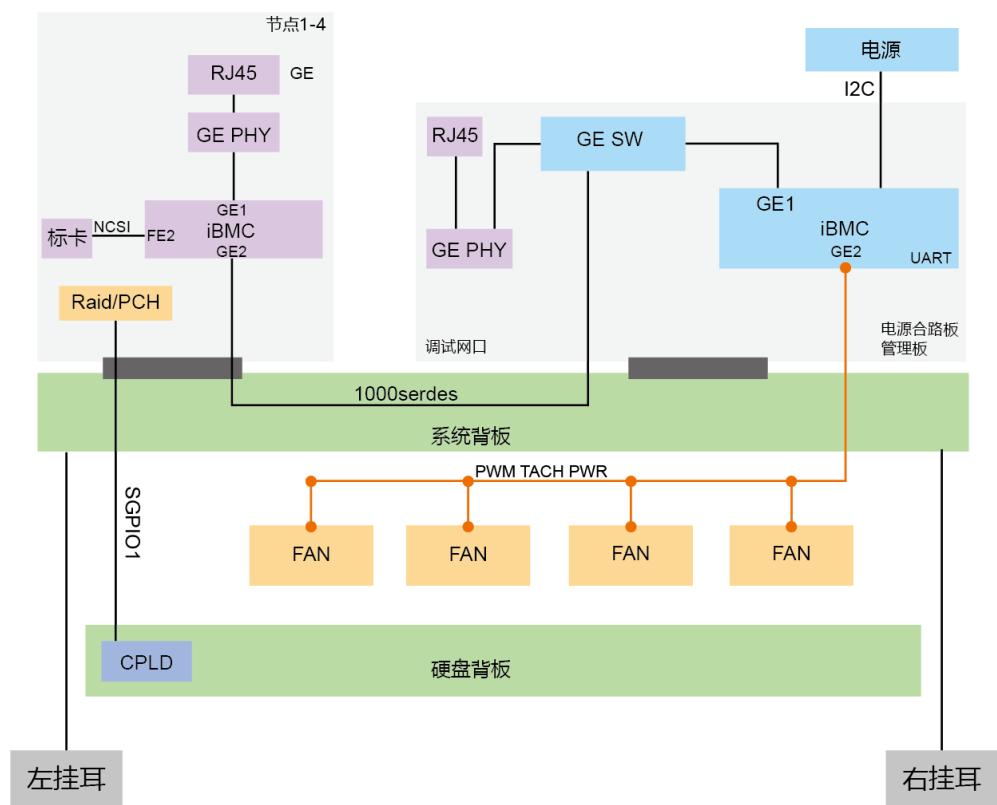

Figure 2-6 X6000 monitoring and management design (Enhanced Chassis)



2.4 Advantages

- The new, self-developed high-density server system architecture supports rear cable routing and maintenance, and maintenance in the cold air area.
- Unified 2U architecture. The NVMe model supports up to 24 NVMe SSDs, and the combined configuration of NVMe SSDs and SAS or SATA HDDs.
- Standard Chassis: The SAS or SATA model supports 24 2.5-inch SAS or SATA drives.
- Enhanced Chassis: The SAS or SATA model supports 24 2.5-inch or 12 3.5-inch SAS or SATA drives.
- The X6000 uses a modular design and supports the hot-swappable server nodes, drives, PSUs, and easy I/O module replacement, improving maintenance efficiency.
- The X6000 employs the unique iBMC+HMM management. The iBMC manages server nodes while the HMM manages the fan modules, PSUs, and chassis assets.
- All nodes share the system power supply and fan modules, improving PSU conversion efficiency and reducing the system heat dissipation energy consumption, which maximizes system energy efficiency.

NOTE

The guide rails and CMA are required for fan module hot swap.

3 Hardware Description

- [3.1 Enhanced Chassis](#)
- [3.2 Standard Chassis](#)

3.1 Enhanced Chassis

3.1.1 Appearance

The X6000 adopts a modular design that separates the chassis from the node. The chassis is a 2 U standard chassis, which fits into a standard 19-inch universal cabinet that is more than 1000 mm (39.37 in.) deep, and supports server nodes of different IO specifications. Customers can choose suitable nodes for deployment according to their business.

Figure 3-1 Front view of an X6000 (with 2.5-inch hard disks)

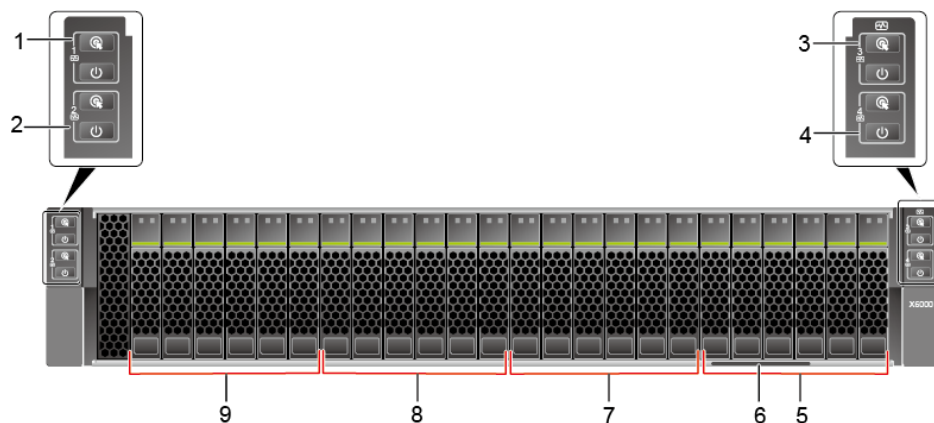

1	Server node 1 indicator area	2	Server node 2 indicator area
3	Server node 3 indicator area	4	Server node 4 indicator area

5	Hard disks managed by server node 4	6	Label (including SN)
7	Hard disks managed by server node 3	8	Hard disks managed by server node 2
9	Hard disks managed by server node 1	-	-

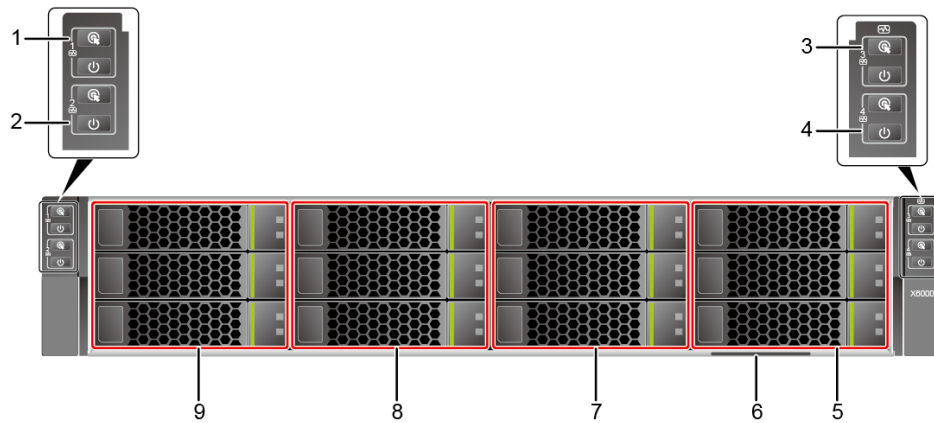

Figure 3-2 Front view of an X6000 (with 3.5-inch hard disks)



1	Server node 1 indicator area	2	Server node 2 indicator area
3	Server node 3 indicator area	4	Server node 4 indicator area
5	Hard disks managed by server node 4	6	Label (including SN)
7	Hard disks managed by server node 3	8	Hard disks managed by server node 2
9	Hard disks managed by server node 1	-	-

Table 3-1 describes the indicators on the mounting ear panel.

Table 3-1 Indicators on the mounting ear panel

Silk Screen	Name	Description
	Node health status indicator	<ul style="list-style-type: none"> • Off: There is no power supply, or the PSU is faulty. • Blinking red at 1 Hz: A major alarm has been generated on the server node. • Blinking red at 5 Hz: A critical alarm has been generated on the server node. • Steady green: The server node is operating properly.
	Power button/indicator	<p>Power indicator</p> <ul style="list-style-type: none"> • Off: The server is not connected to a power source. • Steady yellow: The server is ready to power on. • Steady green: The server is properly powered on. • Blinking yellow: The iBMC is starting. <p>Power button</p> <ul style="list-style-type: none"> • When the server is powered on, you can press this button to shut down the OS. • When the server is powered on, you can hold down this button for 6 seconds to power off the server node by force. • When the server is ready to be powered on, you can press this button to start the server.
	UID button/indicator	<p>The UID button/indicator helps identify and locate a server node in a chassis. You can turn on or off the UID indicator by pressing the UID button or by using the iBMC CLI or WebUI.</p> <p>UID indicator</p> <ul style="list-style-type: none"> • Off: The server node is not being located. • Steady blue: The server node is located. • Blinking blue: The server node has been located and is differentiated from other nodes that have also been located. <p>UID button</p> <ul style="list-style-type: none"> • You can press this button to turn on or off the UID indicator. • You can press and hold down this button for 4 to 6 seconds to reset the server node iBMC.

Silk Screen	Name	Description
	Server health indicator	<ul style="list-style-type: none"> Off: There is no power supply, or the PSU is faulty. Blinking red at 1 Hz: A major alarm has been generated on the server. Blinking red at 5 Hz: A critical alarm has been generated on the server. Steady green: The server node is operating properly.

The X6000 has four server nodes at the rear, two PSUs and supports up to two PCIe cards per node. **Figure 3-3** shows the rear view of an X6000.

Figure 3-3 Rear view of an X6000

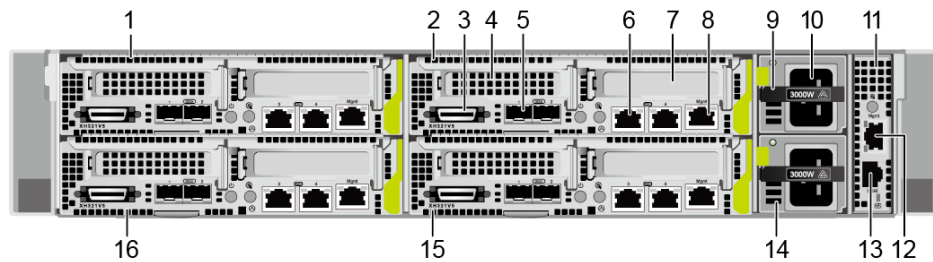

1	Server node 3	2	Server node 1
3	Universal connector port	4	PCIe card/RAID controller card slot
5	10GE LOM optical port	6	GE LOM network port
7	PCIe card slot	8	iBMC management network port
9	PSU 1	10	Power input socket
11	HMM	12	Aggregation network port
13	Serial port	14	PSU 2
15	Server node 2	16	Server node 4

Figure 3-4 and **Table 3-2** show the indicators and buttons on the X6000 rear panel.

Figure 3-4 Indicators and buttons on the X6000 rear panel

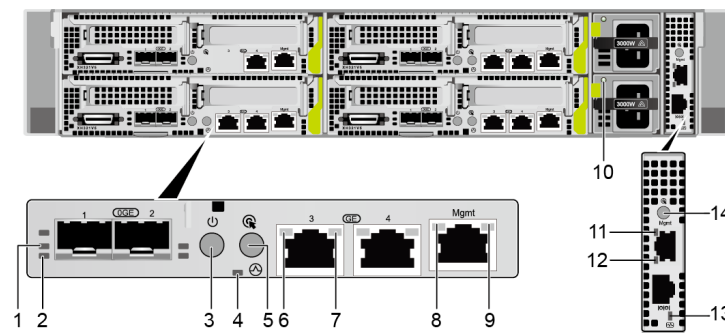







Table 3-2 Indicators and buttons on the X6000 rear panel

No.	Silk Screen	Name	Description
1	-	Transmission rate indicator	<ul style="list-style-type: none"> Off: The network port is not connected. Steady green: The data transmission rate is 10 Gbit/s.
2	-	Connection status indicator/Data transmission status indicator	<ul style="list-style-type: none"> Off: The network port is not connected. Blinking green: Data is being transmitted. Steady green: The network port is properly connected.
3		Power button/indicator	<p>Power indicator</p> <ul style="list-style-type: none"> Off: The server is not connected to a power source. Steady yellow: The server is ready to power on. Steady green: The server is properly powered on. Blinking yellow: The iBMC is starting. <p>Power button</p> <ul style="list-style-type: none"> When the server is powered on, you can press this button to shut down the OS. When the server is powered on, holding down this button for 6 seconds will power off the server node. When the server is ready to be powered on, you can press this button to start the server.

No.	Silk Screen	Name	Description
4		Health indicator	<ul style="list-style-type: none"> ● Off: There is no power supply, or the PSU is faulty. ● Blinking red at 1 Hz: A major alarm has been generated on the server. ● Blinking red at 5 Hz: A critical alarm has been generated on the server. ● Steady green: The server node is operating properly.
5		UID button/indicator	<p>The UID button/indicator helps identify and locate a server node in a chassis. You can turn on or off the UID indicator by pressing the UID button or by using the iBMC CLI or WebUI.</p> <p>UID indicator</p> <ul style="list-style-type: none"> ● Off: The server node is not being located. ● Steady blue: The server node has been located. ● Blinking blue: The server node has been located and is differentiated from other nodes that have also been located. <p>UID button</p> <ul style="list-style-type: none"> ● You can press this button to turn on or off the UID indicator. ● You can press and hold down this button for 4 to 6 seconds to reset the iBMC.
6	-	Data transmission status indicator of the LOM GE network port	<ul style="list-style-type: none"> ● Off: Inactive. ● Steady yellow: Active, but no data is being transmitted. ● Blinking yellow: Data is being transmitted.
7	-	Connection status indicator of the LOM GE network port	<ul style="list-style-type: none"> ● Off: The network port is not connected. ● Steady green: The network port is properly connected.

No.	Silk Screen	Name	Description
8	-	Data transmission status indicator of the iBMC management network port	<ul style="list-style-type: none"> ● Off: No data is being transmitted. ● Blinking yellow: Data is being transmitted.
9	-	Connection status indicator of the iBMC management network port	<ul style="list-style-type: none"> ● Off: The network port is not connected. ● Steady green: The network port is properly connected.
10	-	Power operating status indicator	<ul style="list-style-type: none"> ● Off: No AC power is supplied. ● Steady green: The power input and output are normal. ● Steady orange: The input is normal, but no power output is supplied due to overheat protection, overcurrent protection, short circuit protection, output overvoltage protection, or some component failures. ● Blinking green at 1 Hz: <ul style="list-style-type: none"> – The input is normal, the server node is standby, and the PSU is in MV12 mode. (The output voltage is 12 V.) – The input is overvoltage or undervoltage. – The PSU is in deep hibernation mode. ● Blinking green at 4 Hz: under online firmware upgrade.
11	-	Aggregation network port connection status indicator	<ul style="list-style-type: none"> ● Off: The network port is not connected. ● Steady green: The network port is properly connected.
12	-	Data transmission status indicator for the aggregation network port	<ul style="list-style-type: none"> ● Off: The network port is idle. ● Blinking orange: Data is being transmitted over the network port.

No.	Silk Screen	Name	Description
13		Server health indicator	<ul style="list-style-type: none"> • Off: There is no power supply, or the PSU is faulty. • Blinking red at 1 Hz: A major alarm has been generated on the server. • Blinking red at 5 Hz: A critical alarm has been generated on the server. • Steady green: The server node is operating properly.
14		UID button/indicator	<p>The UID button/indicator helps identify and locate a server in a chassis. You can turn on or off the UID indicator by pressing the UID button or by remotely running a command on the iBMC CLI.</p> <p>UID indicator</p> <ul style="list-style-type: none"> • Off: The server is not being located. • Steady blue: The server has been located. • Blinking blue: The server has been located and is differentiated from other nodes that have also been located. <p>UID button</p> <ul style="list-style-type: none"> • You can press this button to turn on or off the UID indicator. • You can press and hold down this button for 4 to 6 seconds to reset the iBMC.

3.1.2 Structure

The overall structure of the X6000 for the 2.5-inch model is shown in the [Figure 3-5](#).

Figure 3-5 X6000 components

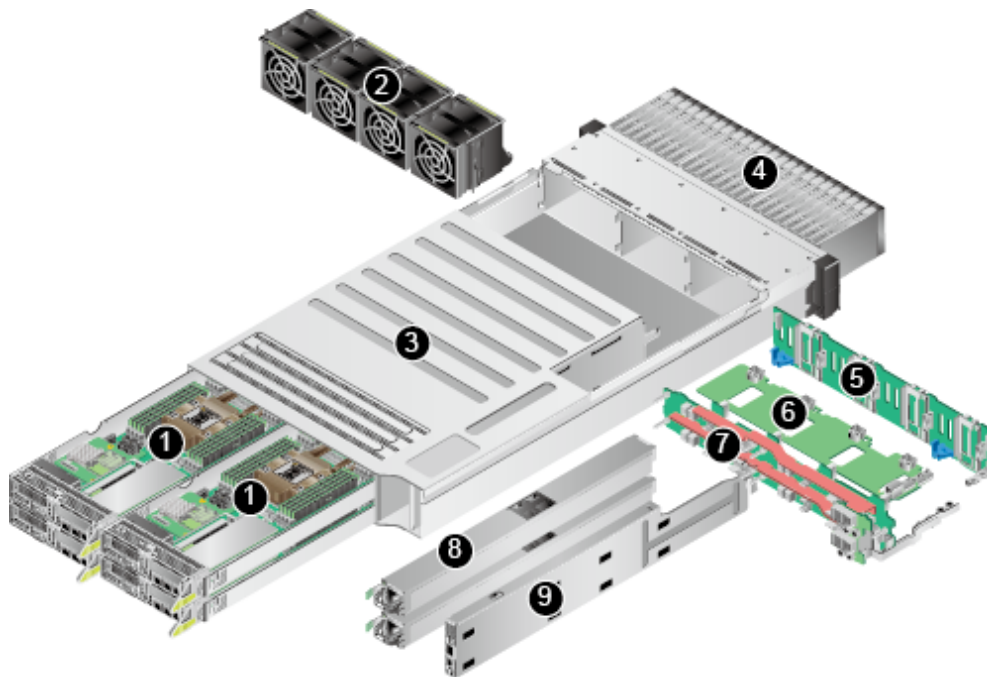

Details about system components in the X6000 is described in [Table 3-3](#)

Table 3-3 X6000 components

No.	Name	Description
1	Server node	XH321 V5.
2	Fan module	Four fan modules in N+1 redundancy mode.
3	Chassis	A 2U chassis housing four server nodes.
4	Hard disk	24 x 2.5-inch hot-swappable SATA/SAS hard disks or NVMe SSDs, or 12 x 3.5-inch hot-swappable SATA/SAS hard disks NOTE If the OS is installed on an NVMe SSD, the BIOS can be set only to UEFI mode.
5	Hard disk backplane	Provides power cable connectors and data transmission channels for hard disks. The X6000 supports three types of hard disk backplanes: <ul style="list-style-type: none"> • Backplane for 2.5-inch SAS/SATA hard disks • Backplane for 2.5-inch NVMe SSDs • Backplane for 3.5-inch SAS/SATA hard disks NOTE The backplane for NVMe SSDs applies to all 2.5-inch hard disks.

No.	Name	Description
6	Fan backplane	Drives the fans in the chassis.
7	System backplane	<p>A passive backplane used for server nodes to transmit signals to the hyper management module (HMM) and the hard disk backplane.</p> <p>NOTE</p> <ul style="list-style-type: none"> • The SAS/SATA hard disk backplane corresponds to the SAS/SATA system backplane. • The NVMe hard disk backplane corresponds to the NVMe system backplane.
8	PSU	<p>Supported 2 x 3000 W AC PSUs (compatible with 240 HVDC)</p> <p>NOTE</p> <ul style="list-style-type: none"> • The X6000 PSUs support 1+1 redundancy mode only when the server power consumption is lower than that of a single server. • If the input power is between 100 V and 130 V, the working power of each PSU will decrease to 1200 W. • If the input power is between 200 V and 220 V, or 240 V HVDC, the working power of each PSU will decrease to 2500 W. • If the input power is between 220 V and 240 V, the working power of each PSU is 3000 W.
9	HMM	<ul style="list-style-type: none"> • Enables chassis management for the X6000, providing ambient temperature monitoring, fan management, PSU management, and node management. • The HMM provides an aggregation network port at the rear of the chassis. The aggregation network port is connected to the iBMC of the four server nodes using one management network cable, so that only one port for the out-of-band management system is displayed to external entities. <p>NOTE To log in to the iBMC of a server node, you need to set the management network port as the aggregation network port.</p>

3.1.3 Server Node

Figure 3-6 shows the server node supported by the X6000 .

Figure 3-6 Appearance of an XH321 V5

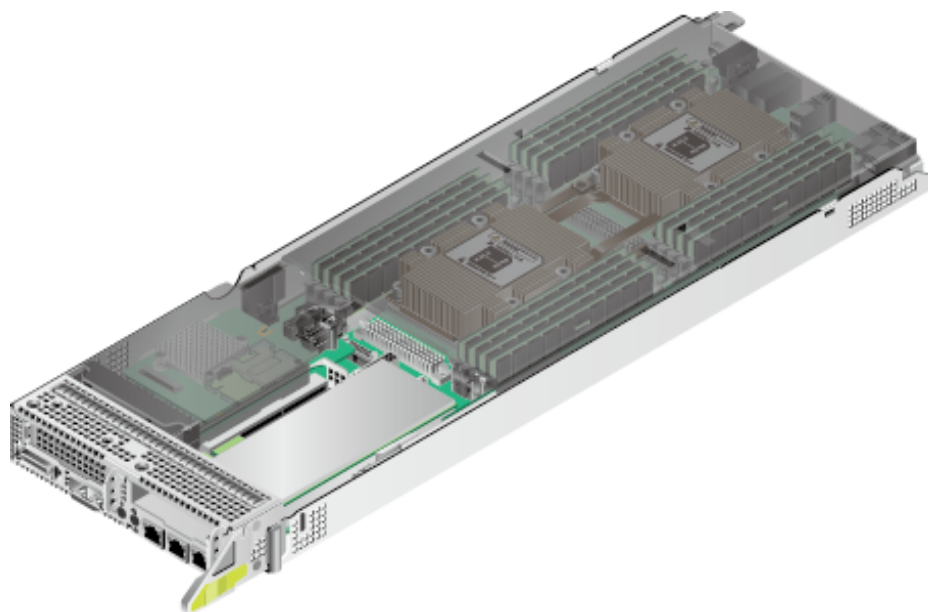

3.1.4 Fan Module

The X6000 features four 8080 high air pressure counter-rotating fans to enhance the cooling capacity of the entire server. The management module automatically adjusts the rotational speed according to the working condition of the server nodes to achieve intelligent cooling, supporting hot-swapping and single fan failure.

Figure 3-7 shows the slots for installing fan modules.

Figure 3-7 Slots for installing fan modules

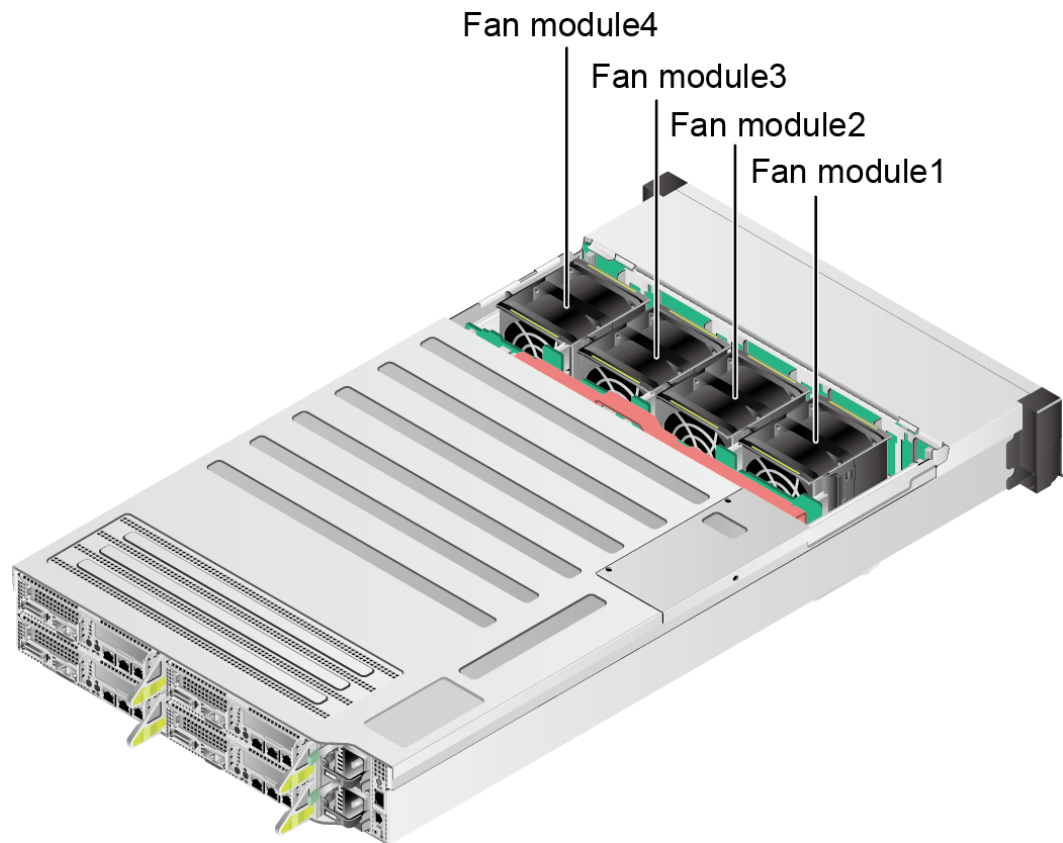

3.1.5 PSU

An X6000 is equipped with two AC or DC PSUs.

Input voltage range :

- AC: 100 V to 130 V AC with an input frequency of 50 or 60 Hz
- AC: 200 V to 220 V AC with an input frequency of 50 or 60 Hz
- AC: 220 V to 240 V AC with an input frequency of 50 or 60 Hz
- 240 V HVDC

The output voltage for the PSUs is 12 V DC.

The following figure shows the appearance of PSU module.

Figure 3-8 Appearance of PSU module



The PSU panel consists of a latch, an input socket, and an operating status indicator, as shown in [Figure 3-9](#).

Figure 3-9 AC PSU panel

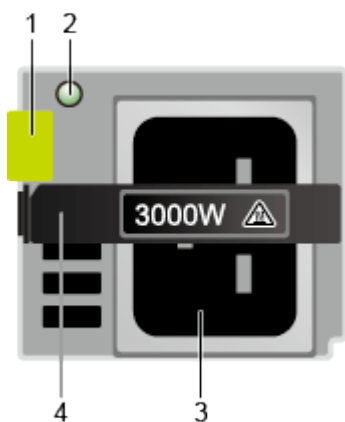

1	Latch	2	Operating status indicator
3	Power input socket	4	Handle

NOTE

C19 16A power cables are required for 3000 W PSUs.

[Table 3-4](#) describes the PSU operating status indicator on the AC PSU panel.

Table 3-4 PSU operating status indicator description

Name	Status	Description
Operating status indicator	Steady green	The power input and output are normal.
	Steady orange	The power input is normal, but no power output is supplied due to overheat protection, overcurrent protection, short circuit protection, output overvoltage protection, or some component failures.
	Blinking green at 1 Hz	The power input is normal, the server is in standby mode, the PSU enters the MV12 mode (output power: 12 V).
		Input overvoltage or undervoltage occurs.
		The PSU enters the deep hibernation mode.
	Blinking green at 4 Hz	Firmware is being upgraded online.
Off	No AC power is supplied.	

Table 3-5 lists the PSUs supported by the X6000.

Table 3-5 PSUs supported by the X6000

BOM	Description	Remarks
02312AEM	Function Module,PAC3000S12-BH,PAC3000S12-BH,Server Power Platinum 3000W	100 V to 130 V AC, 1200 W 200 V to 220 V AC, 2500 W 220 V to 240 V AC, 3000 W 240 V DC, 2500 W

 **NOTE**

The above information is for reference only. For details, use the [Compatibility Checker](#).

3.1.6 System Backplane and Hard Disk Backplane

The system backplane is a passive backplane, mainly used for server nodes to transmit signals to the HMM and to the hard disk backplane.

The hard disk backplane supplies power to hard disks and provides data transmission channels, as shown in [Figure 3-10](#).

Figure 3-10 System backplane and hard disk backplane

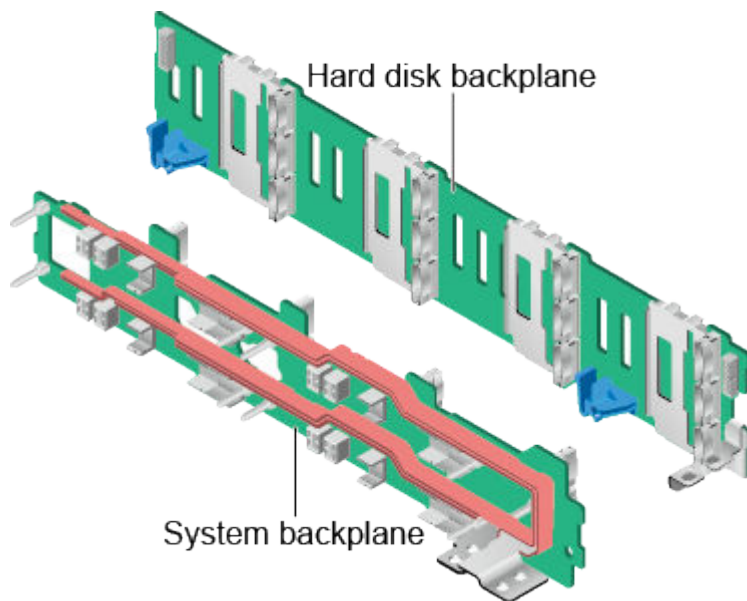

3.1.7 HMM

The HMM implements X6000 management, including ambient temperature monitoring, and fan module, PSU, and node management. Through an aggregation module, the HMM provides an aggregation network port on the chassis rear panel. By connecting only to this aggregation network port, a client can access the iBMC of all server nodes. If this aggregation network port is not used, a standalone management network port is used to connect to the server node iBMC.

Figure 3-11 shows the front view of the port aggregation module.

Figure 3-11 Rear view of the HMM

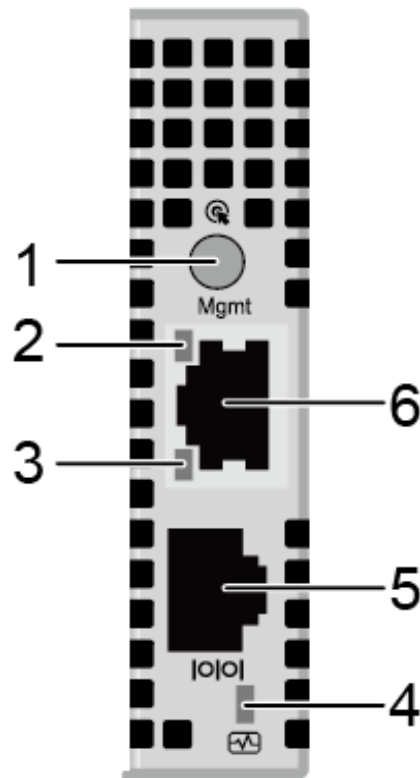

1	UID button/indicator	2	Aggregation network port connection status indicator
3	Data transmission status indicator for the aggregation network port	4	Health indicator
5	Serial port	6	Aggregation network port

3.2 Standard Chassis

3.2.1 Appearance

The X6000 adopts a modular design that separates the chassis from the node. The chassis is a 2 U standard chassis, which fits into a standard 19-inch universal cabinet that is more than 1000 mm (39.37 in.) deep, and supports server nodes of different IO specifications. Customers can choose suitable nodes for deployment according to their business.

Figure 3-12 Front view of an X6000

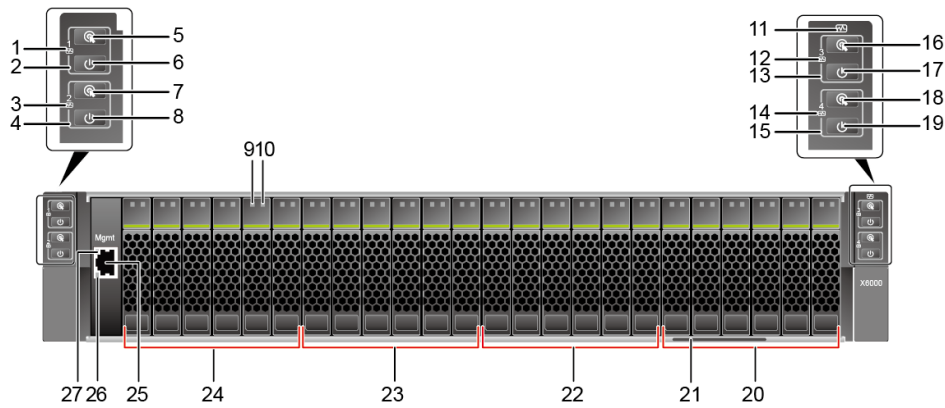





1	Server node 1 health indicator	2	Server node 1 indicator area
3	Server node 2 health indicator	4	Server node 2 indicator area
5	Server node 1 UID button/indicator	6	Server node 1 power button/indicator
7	Server node 2 UID button/indicator	8	Server node 2 power button/indicator
9	Hard disk fault indicator	10	Hard disk activity indicator
11	Server health indicator	12	Server node 3 health indicator
13	Server node 3 indicator area	14	Server node 4 health indicator
15	Server node 4 indicator area	16	Server node 3 UID button/indicator
17	Server node 3 power button/indicator	18	Server node 4 UID button/indicator
19	Server node 4 power button/indicator	20	Hard disks managed by server node 4 (numbered 4-0 to 4-5 from left to right)
21	Slide-out label plate (including an ESN)	22	Hard disks managed by server node 3 (numbered 3-0 to 3-5 from left to right)
23	Hard disks managed by server node 2 (numbered 2-0 to 2-5 from left to right)	24	Hard disks managed by server node 1 (numbered 1-0 to 1-5 from left to right)

25	Aggregation network port	26	Data transmission status indicator for the aggregation network port
27	Aggregation network port connection status indicator	-	-

Table 3-6 describes the indicators on the mounting ear panel.

Table 3-6 Indicators on the mounting ear panel

Silk Screen	Name	Description
	Node health status indicator	<ul style="list-style-type: none"> Off: There is no power supply, or the PSU is faulty. Blinking red at 1 Hz: A major alarm has been generated on the server node. Blinking red at 5 Hz: A critical alarm has been generated on the server node. Steady green: The server node is operating properly.
	Power button/indicator	<p>Power indicator</p> <ul style="list-style-type: none"> Off: The server is not connected to a power source. Steady yellow: The server is ready to power on. Steady green: The server is properly powered on. Blinking yellow: The iBMC is starting. <p>Power button</p> <ul style="list-style-type: none"> When the server is powered on, you can press this button to shut down the OS. When the server is powered on, you can hold down this button for 6 seconds to power off the server by force. When the server is ready to be powered on, you can press this button to start the server.

Silk Screen	Name	Description
	UID button/ indicator	<p>The UID button/indicator helps identify and locate a server node in a chassis. You can turn on or off the UID indicator by pressing the UID button or remotely running a command on the iBMC CLI.</p> <p>UID indicator</p> <ul style="list-style-type: none"> • Off: The server node is not being located. • Steady blue: The server node is located. • Blinking blue: The server node has been located and is differentiated from other nodes that have also been located. <p>UID button</p> <ul style="list-style-type: none"> • You can press this button to turn on or off the UID indicator. • You can press and hold down this button for 4 to 6 seconds to reset the server iBMC.
	Server health indicator	<ul style="list-style-type: none"> • Off: There is no power supply, or the PSU is faulty. • Blinking red at 1 Hz: A major alarm has been generated on the server. • Blinking red at 5 Hz: A critical alarm has been generated on the server. • Steady green: The server is operating properly.

The X6000 has four server nodes at the rear, two PSUs and supports up to two PCIe cards per node and [Figure 3-13](#) shows the rear view of an X6000 standard chassis.

Figure 3-13 Rear view of an X6000

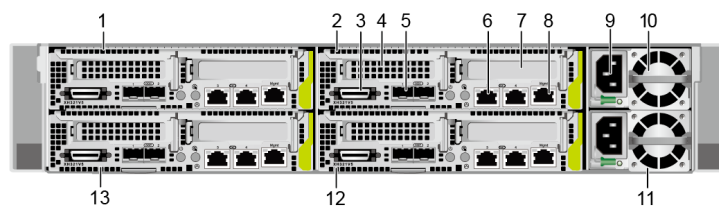

1	Server node 3	2	Server node 1
3	Universal connector port	4	PCIe card/RAID controller card slot

5	10GE LOM optical port	6	GE LOM network port
7	PCIe card slot	8	iBMC management network port
9	Power input socket	10	PSU 1
11	PSU 2	12	Server node 2
13	Server node 4	-	-

Figure 3-14 and Table 3-7 describe the indicators and buttons on the XH321 V5 node panel.

Figure 3-14 Indicators and buttons on the X6000 rear panel

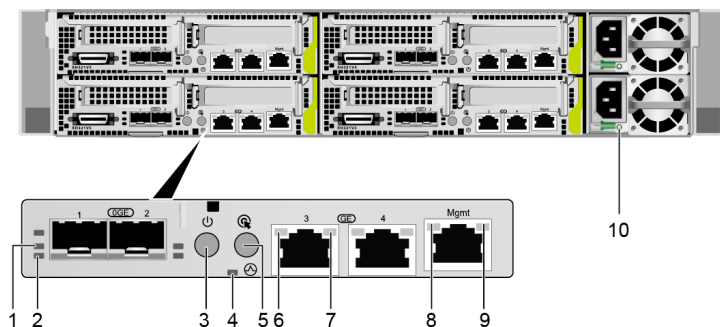





Table 3-7 Indicators and buttons on the XH321 V5 node panel

No.	Silk Screen	Name	Description
1	-	Transmission rate indicator	<ul style="list-style-type: none"> ● Off: The network port is not connected. ● Steady green: The data transmission rate is 10 Gbit/s.
2	-	Connection status indicator/Data transmission status indicator	<ul style="list-style-type: none"> ● Off: The network port is not connected. ● Steady green: The network port is properly connected. ● Blinking green: Data is being transmitted.

No.	Silk Screen	Name	Description
3		Power button/ indicator	<p>Power indicator</p> <ul style="list-style-type: none"> ● Off: The server is not powered on. ● Steady yellow: The server is ready to power on. ● Steady green: The server is properly powered on. ● Blinking yellow: The iBMC is starting. <p>Power button</p> <ul style="list-style-type: none"> ● When the server is powered on, you can press this button to shut down the OS. ● When the server is powered on, you can hold down this button for 6 seconds to power off the server by force. ● When the server is ready to be powered on, you can press this button to start the server.
4		Health indicator	<ul style="list-style-type: none"> ● Off: There is no power supply, or the PSU is faulty. ● Blinking red at 1 Hz: A major alarm has been generated on the server node. ● Blinking red at 5 Hz: A critical alarm has been generated on the server node. ● Steady green: The server node is operating properly.

No.	Silk Screen	Name	Description
5		UID button/indicator	<p>The UID button/indicator helps identify and locate a server node in a chassis. You can turn on or off the UID indicator by pressing the UID button or remotely running a command on the iBMC CLI.</p> <p>UID indicator</p> <ul style="list-style-type: none"> ● Off: The server node is not being located. ● Steady blue: The server node has been located. ● Blinking blue: The server node has been located and is differentiated from other nodes that have also been located. <p>UID button</p> <ul style="list-style-type: none"> ● You can press this button to turn on or off the UID indicator. ● You can press and hold down this button for 4 to 6 seconds to reset the server iBMC.
6	-	Data transmission status indicator of the LOM GE network port	<ul style="list-style-type: none"> ● Off: No data is being transmitted. ● Blinking yellow: Data is being transmitted.
7	-	Connection status indicator of the LOM GE network port	<ul style="list-style-type: none"> ● Off: The network port is not connected. ● Steady green: The network port is properly connected.
8	-	Data transmission status indicator of the iBMC management network port	<ul style="list-style-type: none"> ● Off: No data is being transmitted. ● Blinking yellow: Data is being transmitted.
9	-	Connection status indicator of the iBMC management network port	<ul style="list-style-type: none"> ● Off: The network port is not connected. ● Steady green: The network port is properly connected.

No.	Silk Screen	Name	Description
10	-	Power operating status indicator	<ul style="list-style-type: none"> • Off: No power is supplied. • Steady green: The power input and output are normal. • Steady orange: The power input is normal, but no power output is supplied due to overheat protection, overcurrent protection, short circuit protection, output overvoltage protection, or some component failures. • Blinking green at 1 Hz: <ul style="list-style-type: none"> –The input is normal, the server is standby, and the PSU is in MV6 mode. (The output voltage is 6.7 V.) –The input is overvoltage or undervoltage. –The PSU is in deep hibernation mode. • Blinking green at 4 Hz: Firmware is being upgraded online.

3.2.2 Structure

The overall structure of the X6000 is shown in [Figure 3-15](#).

Figure 3-15 X6000 components

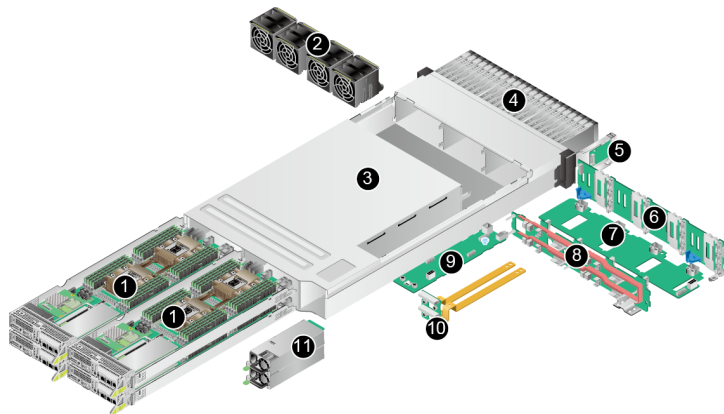

Details about system components in the X6000 is described in [Table 3-8](#).

Table 3-8 X6000 components

No.	Name	Description
1	Server node	XH321 V5.

No.	Name	Description
2	Fan module	Four fan modules in N+1 redundancy mode.
3	Chassis	A 2U chassis housing four server nodes.
4	Hard disk	24 x 2.5-inch hot-swappable SATA/SAS hard disks or NVMe SSDs. NOTE If the OS is installed on an NVMe SSD, the BIOS can be set only to UEFI mode.
5	Port aggregation module	Provides an aggregation network port connected to the iBMC of the four server nodes using one management network cable. This means that only one port for the out-of-band management system interfaces with external devices. NOTE Before configuring an aggregation network port, you must configure the management network port on the node board to the aggregation mode.
6	Hard disk backplane	Provides power cable connectors and data transmission channels for hard disks. The X6000 supports two types of hard disk backplanes: <ul style="list-style-type: none"> • Backplane for 2.5-inch SAS/SATA hard disks • Backplane for 2.5-inch NVMe SSDs NOTE The backplane for NVMe SSDs applies to all hard disks.
7	Fan backplane	Drives the fans in the chassis.
8	System backplane	A passive backplane used for server nodes to transmit signals to the hyper management module (HMM) and the hard disk backplane. NOTE <ul style="list-style-type: none"> • The SAS/SATA hard disk backplane corresponds to the SAS/SATA system backplane. • The NVMe hard disk backplane corresponds to the NVMe system backplane.
9	HMM	Enables chassis management for the X6000, providing ambient temperature monitoring, fan management, PSU management, and node management.
10	PSU backplane + system power copper strip	Connect the PSUs, HMM, system backplanes, and hard disk backplane, and provide power to the server.

No.	Name	Description
11	PSU	<p>Supported PSUs:</p> <ul style="list-style-type: none"> ● 2 x 1500 W AC PSUs (compatible with 240 HVDC) ● 2 x enhanced 1500 W AC PSUs (compatible with 240 HVDC) ● 2 x 2000 W AC PSUs (compatible with 240 HVDC) ● 2 x 1200 W DC PSUs <p>NOTE</p> <ul style="list-style-type: none"> ● The X6000 PSUs support 1+1 redundancy mode only when the server power consumption is lower than that of a single server. ● If the input power is between 100 V and 120 V, the working power of 1500 W PSUs decreases to 1000 W. ● If the input power is between 100 V and 127 V, the working power of enhanced 1500 W PSUs decreases to 1000 W. ● If the input power is between 200 V and 240 V, or 240 V HVDC, the working power of 1500 W PSUs is 1500 W. ● If the input power is between 200 V and 240 V, or 240 V HVDC, the working power of enhanced 1500 W PSUs is 1700 W. ● If the input power is between 200 V and 220 V, the working power of 2000 W PSUs is 1800 W. ● If the input power is between 220 V and 240 V, or 240 V HVDC, the working power of 2000 W PSUs is 2000 W. ● If the input power is between -48 V and -60 V, the working power of 1200 W DC PSUs is 1200 W.

3.2.3 Server Node

Figure 3-16 shows the server node supported by the X6000.

Figure 3-16 Appearance of an XH321 V5

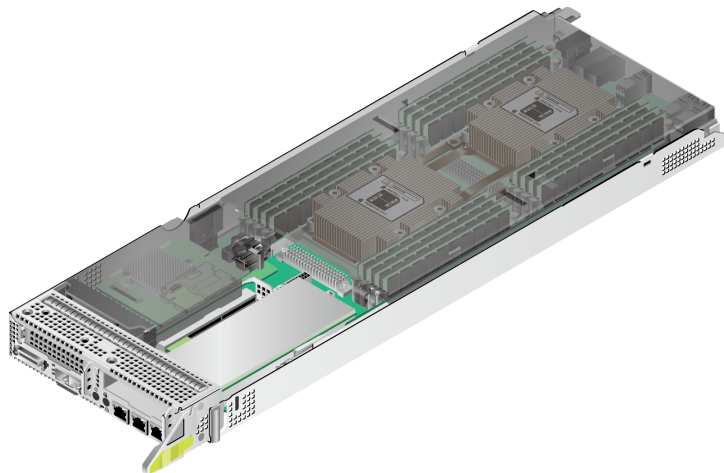

3.2.4 Fan Module

The X6000 uses four 8080 counter rotary fans with high air flow pressure to improve its heat dissipation capability. The HMM controls the fan speed based on server node operating status to implement intelligent heat dissipation, and single-fan failures are allowed.

Figure 3-17 shows the slots for installing X6000 fan modules.

Figure 3-17 Slots for installing X6000 fan modules

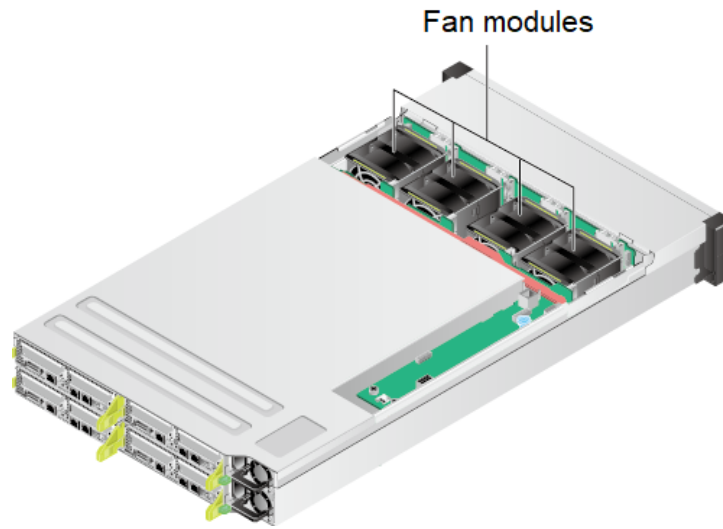

3.2.5 PSU

An X6000 server is equipped with two AC or DC PSUs.

Input voltage range :

- AC: 100 V to 240 V AC with an input frequency of 50 or 60 Hz
- DC: -48 V to -60 V DC
- 240 V HVDC

The output voltage for the PSUs is 12 V DC.

Figure 3-18 and **Figure 3-19** show the appearance of an AC PSU.

Figure 3-18 AC PSU (1500W)



Figure 3-19 AC PSU (2000W)

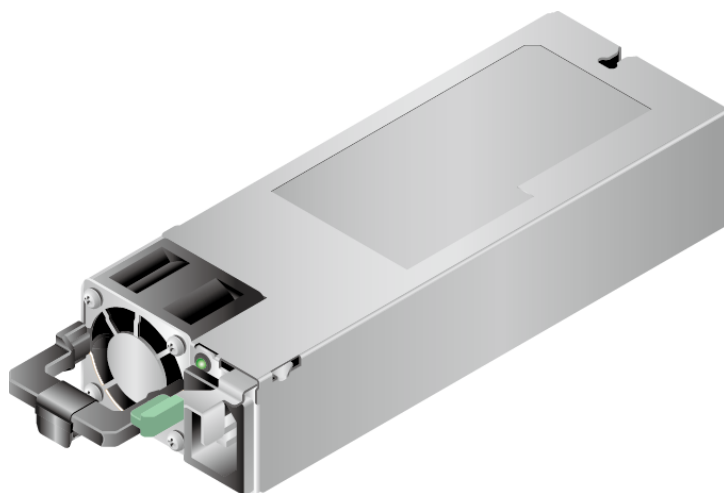
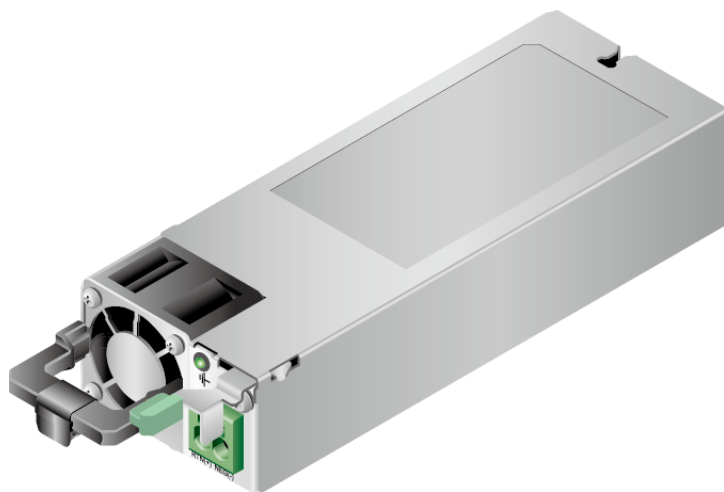

Figure 3-20 shows the DC PSU.

Figure 3-20 DC PSU



An AC PSU panel consists of a latch, an input socket, and an operating status indicator, as shown in [Figure 3-21](#) and [Figure 3-22](#).

Figure 3-21 AC PSU panel (1500W AC PSU)

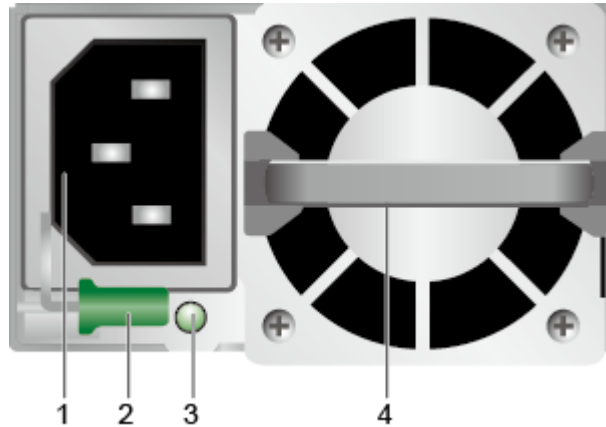

1	Power input socket	2	Latch
3	Operating status indicator	4	Handle

Figure 3-22 AC PSU panel (2000W AC PSU)

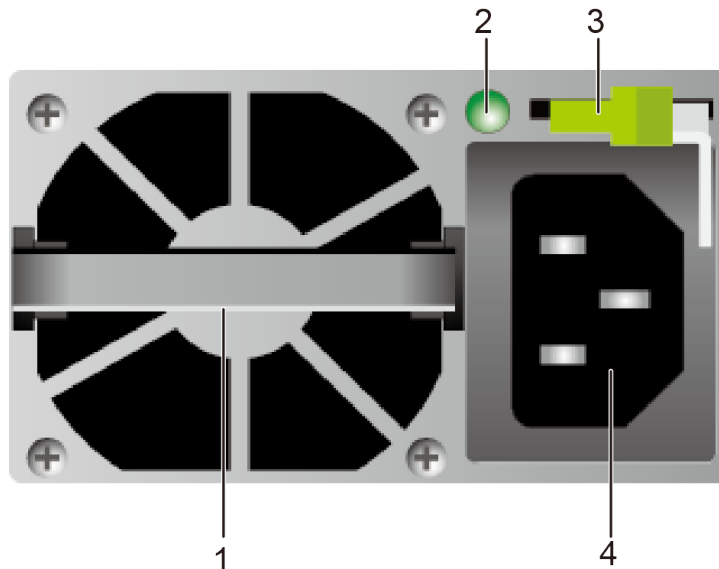

1	Handle	2	Operating status indicator
3	Latch	4	Power input socket

A DC PSU has a handle, an operating status indicator, a latch, a ground terminal, an NEG (-) wiring terminal, and an RTN (+) wiring terminal, as shown in **Figure 3-23**.

Figure 3-23 DC PSU panel

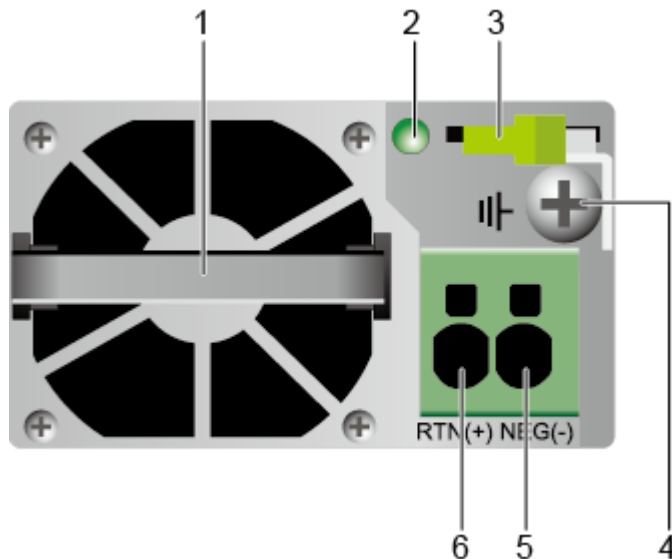

1	Handle	2	Operating status indicator
3	Latch	4	Ground terminal
5	NEG(-) wiring terminal	6	RTN(+) wiring terminal

Table 3-9 describes the indicator on the AC or DC PSU panel.

Table 3-9 PSU operating status indicator description

Name	Status	Description
Operating status indicator	Steady green	The power input and output are normal.
	Steady orange	The power input is normal, but no power output is supplied due to overheat protection, overcurrent protection, short circuit protection, output overvoltage protection, or some component failures.
	Blinking green at 1 Hz	The power input is normal, the server is in standby mode, and the PSU enters the MV6 mode (output power: 6.7 V).
		Input overvoltage or undervoltage occurs.
		The PSU enters the deep hibernation mode.

Name	Status	Description
	Blinking green at 4 Hz	Firmware is being upgraded online.
	Off	No power is supplied.

Table 3-10 lists the PSUs supported by the X6000.

Table 3-10 PSUs supported by the X6000

BOM	Description	Remarks
02131268	AC-DC Power,5degC,55degC, 90V,264V,12V/125A	<ul style="list-style-type: none"> • 1000 W @100 V to 120 V AC • 1500 W @200 V to 240 V AC • 1500 W @240HVDC
02131336	AC-DC Power,5degC,55degC, 90V,264V,12V/125A Enhanced 1500 W PSU	<ul style="list-style-type: none"> • 1000 W @100 V to 127 V AC • 1700 W @200 V to 240 V AC
02312DAE	Function Module,PAC1500S12-BE,PAC1500S12-BE,Server Platinum 1500W power supply	<ul style="list-style-type: none"> • 1700 W @240HVDC <p>NOTE Both of them are enhanced 1500 W PSUs. When two PSUs are configured, each PSU can provide a load capacity of 1700 W and function as a 1700 W PSU.</p>
02312AHK	Function Module,PAC2000S12-BE,PAC2000S12-BE,Function Module,PAC2000S12-BE,PAC2000S12-BE,Server Platinum 2000W,power supply	<ul style="list-style-type: none"> • 1800 W @200 V to 220 V AC • 2000 W @220 V to 240 V AC • 2000 W @240HVDC
02312GEN	Function Module,Server Product,PDC1200S1201,1200W DC_Power_Supply Module (including DC_power line)	-48 V DC to -60 V DC, 1200W

 **NOTE**

The above information is for reference only. For details, use the [Compatibility Checker](#).

3.2.6 System Backplane and Hard Disk Backplane

The system backplane is a passive backplane, mainly used for server nodes to transmit signals to the HMM and to the hard disk backplane.

The hard disk backplane supplies power to hard disks and provides data transmission channels, as shown in [Figure 3-24](#).

Figure 3-24 System backplane and hard disk backplane

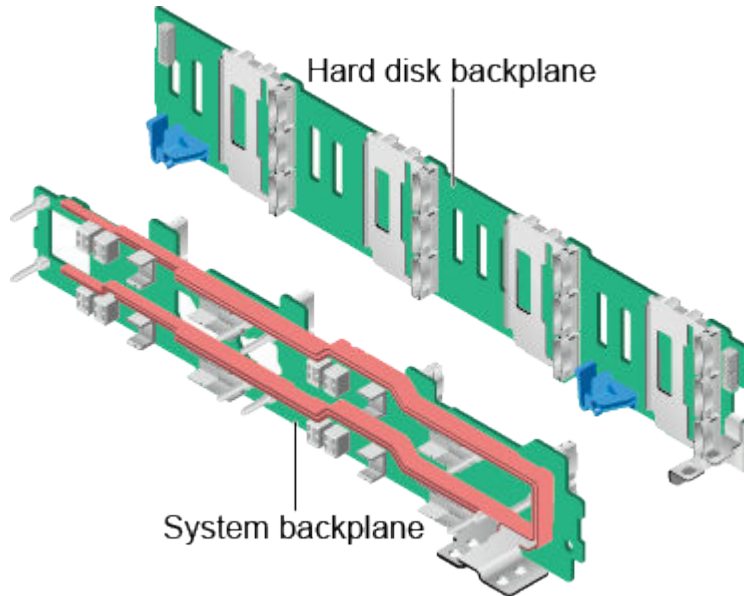

3.2.7 HMM

The HMM implements X6000 management, including ambient temperature monitoring, and fan module, PSU, and node management. Through an aggregation module, the HMM provides an aggregation network port on the chassis front panel. By connecting only to this aggregation network port, a client can access the iBMC of all server nodes. If this aggregation network port is not used, a standalone management network port is used to connect to the server node iBMC.

[Figure 3-25](#) shows the front view of the port aggregation module.

Figure 3-25 Front view of the port aggregation module

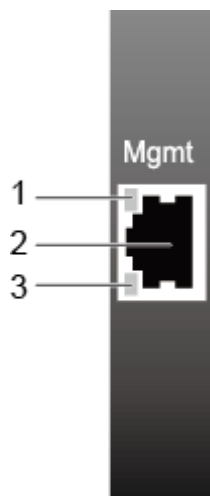

1	Aggregation network port connection status indicator	2	Aggregation network port
3	Data transmission status indicator for the aggregation network port	-	-

4 Security Management

4.1 Server Nodes

4.2 HMM

4.1 Server Nodes

Server nodes support security solutions based on the Trusted Platform Module (TPM).

The TPM is a security chip that complies with the Trusted Computing Group (TCG) TPM specification. The TPM, as a hardware-based system security function module, provides data encryption, password protection, authentication, and internal resource protection. The XH321 V5 supports TPM 2.0.

The TPM is connected to the mainboard through a port. You can access a server node with the TPM only after authorization and authentication or in a specific way, which ensures data security based on hardware.

4.2 HMM

This topic describes command line-based hierarchical protection, remote Secure Shell (SSH) login, and Simple Network Management Protocol (SNMP) encrypted authentication for the HMM.

Command Line-based Hierarchical Protection

When a user attempts to log in to the HMM through an Ethernet port, the HMM must authenticate the user to ensure security. Only the user that passes the authentication can log in to the HMM to configure and maintain the HMM.

The HMM uses a hierarchical protection mode for commands, defining three command levels: monitoring level, configuration level, and management level. These command levels are listed in ascending order. Similarly, login users are also classified into three levels: common user, operator, and administrator. After logging to the HMM, users can use only the commands of the levels that are equal to or lower than their own levels. This mechanism effectively controls the authority of login users.

Remote SSH Login

The HMM supports Secure Shell (SSH). SSH ensures security and provides authentication for user logins and defends user logins against various attacks on an insecure network. The HMM also supports Secure File Transfer Protocol (SFTP) to provide encryption protection for file transfer.

SNMP Encrypted Authentication

The HMM supports the SNMPv3 and SNMPv3 trap encrypted authentication. When being managed by a network management station through the SNMP protocol, the HMM uses the encrypted authentication mode in user-based security model (USM) to ensure security.

The authentication of SNMPv3 and SNMPv3 trap of the HMM supports MD5 or SHA, and the encryption supports DES or AES. The authentication is based on MD5 by default, which is not secure and easy to be cracked. You are advised to change to the SHA algorithm.

NOTE

The HMM also supports the SNMPv1, SNMPv2c, FTP, and Telnet protocol, which are disabled by default for security purposes. If you need to use the functions, contact the local sales representative.

5 System Management Features

The X6000 provides the HMM+iBMC management architecture. The HMM is in charge of chassis management, including the management of fan modules, PSUs, and the chassis, while the iBMC is responsible for node management based on a user interface (UI).

- Independent node management
The X6000 uses the next-generation iBMC intelligent management system to implement remote server management. The iBMC complies with IPMI 2.0 specifications and provides highly reliable hardware monitoring and management.
- Chassis management
The X6000 uses the next-generation HMM management system to manage heat dissipation, power supply, and asset information of shared components. The HMM information is displayed to customers on the iBMC. Customers can access the iBMC either through the management network port of a node or through the aggregation network port on the rear panel.

[5.1 iBMC Features](#)

[5.2 HMM Features](#)

[5.3 Management Principles](#)

[5.4 Management Mode](#)

5.1 iBMC Features

The Baseboard Management Controller (iBMC) provides the following features:

- Supports KVM and text console redirection.
- Supports remote virtual media.
- Complies with Intelligent Platform Management Interface (IPMI) V2.0.
- Supports SNMPv3.
- Supports the common information model (CIM).
- Provides a graphical web user interface to facilitate user management.

Table 5-1 describes the iBMC specifications.

Table 5-1 iBMC specifications

Specifications	Description
Management interfaces	Supports the following management interfaces for system integration: <ul style="list-style-type: none"> ● IPMI V2.0 ● CLI ● HTTPS ● SNMPv3 ● WebUI ● Redfish
Node fault detection	Detects and locates hardware faults accurate down to components.
Node alarm management	Manages alarms and reports alarms in various ways such as over the SNMP trap, Simple Mail Transfer Protocol (SMTP), and syslog service. Alarm management ensures that the server node operates reliably 24/7.
Integrated virtual KVM	Provides remote maintenance and supports a maximum resolution of 1280 x 1024.
Integrated virtual media	Virtualizes local media devices or images to media devices on a remote server, simplifying OS installation. (The virtual DVD-ROM drive supports a maximum transmission rate of 8 MB/s.)
WebUI	Provides a visual WebUI to simplify configuration and operation. The iBMC WebUI supports the following browsers: <ul style="list-style-type: none"> ● Internet Explorer 9.0/10.0/11.0 ● Mozilla Firefox 26.0 or later ● Chrome 21.0 or later ● Safari 8.0 Compatible JRE environments are as follows: <ul style="list-style-type: none"> ● JRE 1.7.0 ● JRE 1.8.0
Fault reproduction	Reproduces faults to facilitate fault diagnosis.
Screen snapshot and screen video	Allows users to view screen snapshots and videos without logging in, facilitating preventive maintenance inspection (PMI).
Domain name service (DNS) and directory service	Supports domain management and directory services, significantly simplifying network and configuration management.

Specifications	Description
Dual-image backup	Starts software from a backup image if the software fails.
IPv6	Supports IPv6 to ensure that enough IP addresses are available.

5.2 HMM Features

The Hyper Management Module (HMM) supports:

- IPMI V2.0
- Command line interface (CLI)

Table 5-2 describes the HMM features.

Table 5-2 HMM features

Specifications	Description
Server management port	Supports the following management interfaces integrated with any standard management system: <ul style="list-style-type: none"> • IPMI V2.0 • CLI
Server fault detection	Detects and locates hardware faults accurate down to components.
Server alarm management	Supports alarm management and reports alarms in various ways, such as syslog service, to ensure uninterrupted 24/7 system operation.
Chassis asset management	Provides intelligent asset management.
Intelligent power management	Uses the power capping technology to increase deployment density and the dynamic energy saving technology to lower O&M costs.
Aggregation network port	Provides out-of-band management of the server nodes. You can use the aggregation network port provided by the aggregation module to connect to the iBMC of all the server nodes, reducing the number of cables required for the management network and lowering system maintenance time.

5.3 Management Principles

The management principles of the X6000 are as follows:

- Each server node is configured with an iBMC management module that provides management functions, such as IPMI, KVM, and virtual drives. The Hyper Management Module (HMM) manages fan modules, PSUs, and chassis assets.
- The iBMC provides a user interface (UI). You can use the iBMC management network port of each server node or the aggregation network port provided by the port aggregation module to connect to the iBMC of each server node.
- The HMM uses the fan backplane to monitor and manage fans. The fan backplane provides four independent pulse-width modulation (PWM) control signals for controlling the fan speed and eight TACH signals for detecting the fan speed.

The HMM uses speed adjustment algorithms to determine a fan speed based on the temperature of temperature-sensitive components and the environment, and sends fan speed data to the fan backplane. The fan backplane also receives fan speed signals from the fan modules to monitor the fan operating status, and reports the status to the HMM for fan health management.

- PSU monitoring and management: The HMM provides one inter-integrated circuit (I2C) for managing the PSUs and general purpose input/output (GPIO) pins for detecting the PSU installation status and PWROK state.

The HMM supports queries on PSU input power, PSU installation status, and PSU alarms.

5.4 Management Mode

Access Mode

The Intelligent Baseboard Management Controller (iBMC) and Hyper Management Module (HMM) provide independent IP addresses to enable users to manage the X6000 .

- On a server node, users can use:
 - The iBMC management port to access the iBMC.
 - The NIC service port to access the iBMC in NC-SI mode.
 - The iBMC management port to access the HMM in transparent transmission mode.
- On a Hyper Management Module, users can use:
 - The aggregation network port to access the HMM.
 - The aggregation network port to access the iBMC in aggregated management mode.

Cable Routing

X6000 provides various access modes and the management network cabling methods are as follows:

- Point-to-point cabling
The out-of-band management network cable is routed from a server node (default configuration in the BIOS), as shown in [Figure 5-1](#).

Figure 5-1 Point-to-point cabling (Enhanced Chassis)

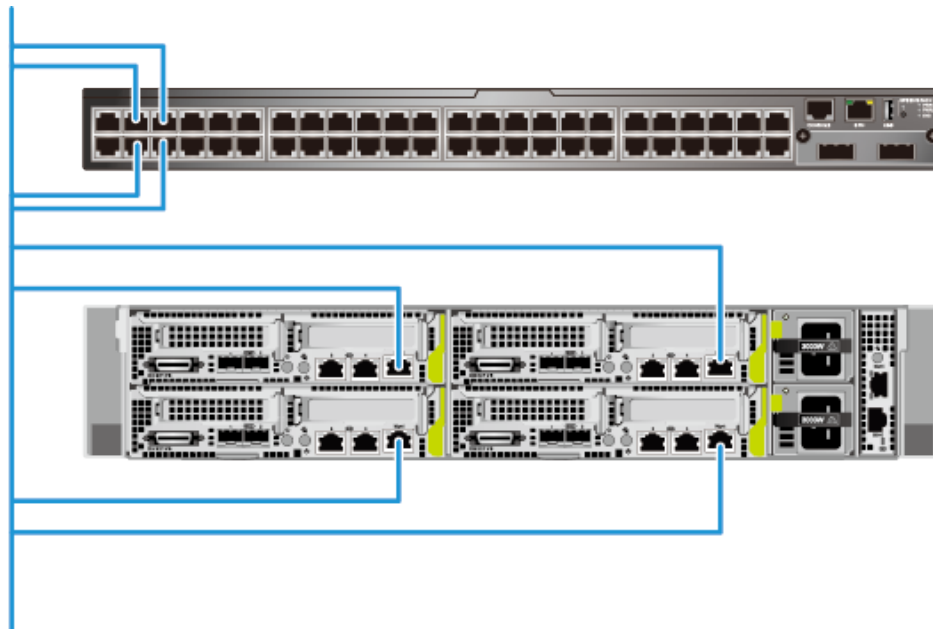

NOTE

- In NC-SI mode, the management network cable can also be used as a service network cable and connected to a service network port.
- The point-to-point cabling method of the enhanced chassis is the same as that of the standard chassis. The following figure uses the enhanced chassis as an example.
- Aggregation management cabling
A server node is accessed through the aggregation network port over the out-of-band management network. The network cable is connected to the aggregation network port, as shown in [Figure 5-2](#) and [Figure 5-3](#).

NOTE

The default configuration in the BIOS is the point-to-point cabling. To change it to aggregation management cabling, see "Logging In to the iBMC CLI or WebUI of a Server Node Through the Aggregation Network Port" in the [FusionServer X6000 Server V100R005 User Guide](#).

Figure 5-2 Aggregation management cabling (Enhanced Chassis)

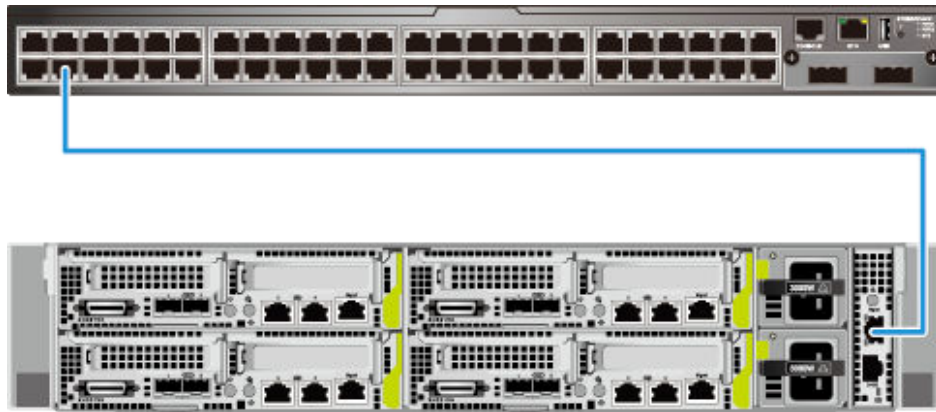
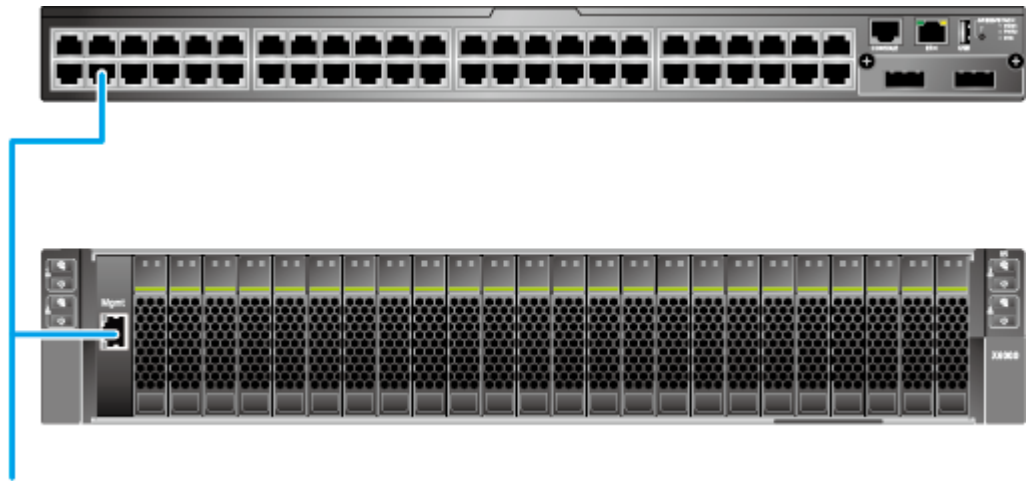

Figure 5-3 Aggregation management cabling (Standard Chassis)



6 Product Specifications

[6.1 Enhanced Chassis](#)

[6.2 Standard Chassis](#)

6.1 Enhanced Chassis

6.1.1 Chassis Specifications

Table 6-1 provides the technical specifications of the X6000

Table 6-1 X6000 technical specifications

Component	Specifications
Form factor	2U multi-node server
Server nodes	2U4 nodes
Management ports	<ul style="list-style-type: none"> One aggregation network port on the server chassis for unified chassis management One management port on each server node
PSUs	Two 3000 W AC (or 240 HVDC) PSUs NOTE <ul style="list-style-type: none"> The X6000 PSUs support 1+1 redundancy mode only when the server power consumption is lower than the power of a single PSU. If the input power is between 100 V and 130 V, the working power of each PSU will decrease to 1200 W. If the input power is between 200 V and 220 V, or 240 V HVDC, the working power of each PSU will decrease to 2500 W. If the input power is between 220 V and 240 V, the working power of each PSU is 3000 W.
Fan modules	Four fan modules in N+1 redundancy mode

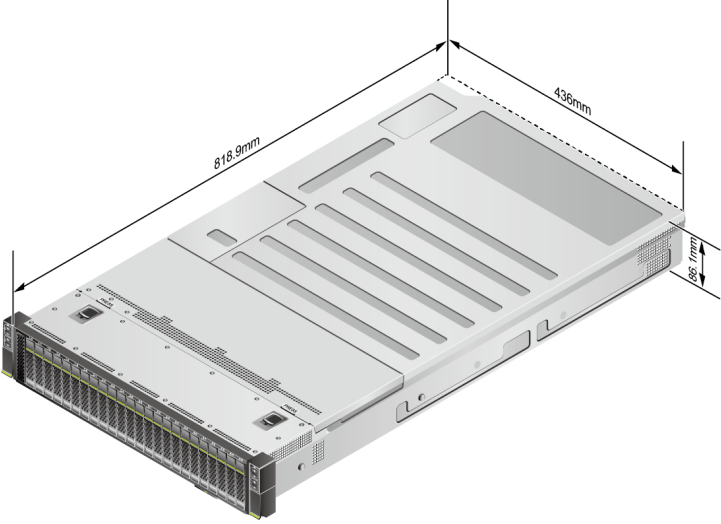
Component	Specifications
Dimensions (H x W x D)	<ul style="list-style-type: none"> ● Server with 2.5-inch hard disks: 86.1 mm (3.39 in.) × 436 mm (17.17 in.) × 818.9 mm (32.24 in.) ● Server with 3.5-inch hard disks: 86.1 mm (3.39 in.) × 436 mm (17.17 in.) × 866.9 mm (34.13 in.) <p>Figure 6-1 Physical dimensions (example: 2.5" drive chassis)</p>  <p>NOTE</p> <ul style="list-style-type: none"> ● The depth includes the mounting ear size. ● The minimum cabinet depth is 1 m (3.28 ft.). ● See Figure 6-1 for methods in measuring physical dimensions of the chassis. ● Methods measuring 3.5" and 2.5" drive chassis are the same. The 2.5" drive chassis is used as an example.
Weight	<ul style="list-style-type: none"> ● Server with 2.5-inch hard disks: 40 kg (88.20 lb) ● Server with 3.5-inch hard disks: 45 kg (99.23 lb) ● Packing: 4.75 kg (10.47 lb)

6.1.2 Server Node Specifications

Table 6-2 provides the specifications of XH321 V5 nodes supported by the X6000.

Table 6-2 Server node specifications

Type	Model	Specifications
Chassis	X6000	A 2U chassis housing four server nodes.

Type	Model	Specifications
Server node	XH321 V5	It provides the following hardware components: <ul style="list-style-type: none"> • One or two Intel® Xeon® Scalable processors (Skylake, Cascade Lake). • Maximum number of DDR4 DIMMs: 16 • 6 x 2.5-inch SAS/SATA hard disks or NVMe SSDs, or 3 x 3.5-inch SAS/SATA hard disks. • One TPM • 2 x M.2 SATA SSD cards • 2 x half-height half-length standard PCIe cards (standard PCIe card slot 1 available for a RAID controller card).

 **NOTE**

The maximum I/O bandwidth of XH321 V5 hard disks managed through the southbridge is 1.9 GB/s due to the bandwidth limit of the SATA controller integrated in the southbridge.

6.1.3 PSU and Power

The X6000 provides two slots for installing PSUs. [Table 6-3](#) describes PSUs and power consumption.

Table 6-3 Power supply

PSU Type	PSU Power Rating	Input Voltage	Maximum Input Current per PSU	Output Voltage
3000W PSUs	3000W	100V ~130V AC, 50Hz/60Hz	16A	12V
		200V ~220V AC, 50Hz/60Hz	16A	
		220V ~240V AC, 50Hz/60Hz	16A	
		240V DC	13A	

 **NOTE**

For details about the BOM number of the PSU, use the [Compatibility Checker](#).

6.1.4 Environmental Specifications

Table 6-4 Environmental specifications

Item	Specifications
Temperature	<ul style="list-style-type: none"> ● Operating temperature: 5°C to 35°C (41°F to 95°F) (ASHRAE Class A2 compliant) ● Storage temperature (within three months): –30°C to +60°C (–22°F to +140°F) ● Storage temperature (within six months): –15°C to +45°C (5°F to 113°F) ● Storage temperature (within one year): –10°C to +35°C (14°F to 95°F) ● Maximum rate of temperature change: 20°C (36°F) per hour, 5°C (9°F) per 15 minutes <p>NOTE</p> <ul style="list-style-type: none"> ● If a single fan fails, the maximum operating temperature decreases from 35°C (95°F) to 30°C (86°F). ● If the server node is configured with processors of 125 W or above, the failure of a single fan may affect the server node performance or cause overheating alarms. You can resolve the issue by replacing the faulty fan. ● For the maximum temperature supported by the server configured with a supercapacitor, optical modules, or 240G M.2 RAID controller card, see Table 6-5, Table 6-6, and Table 6-7.
Relative humidity (RH, non-condensing)	<ul style="list-style-type: none"> ● Operating humidity: 8% to 90% ● Storage humidity (within six months): 5% to 85% ● Storage humidity (within one year): 20% to 75% ● Maximum change rate: 20%/h
Altitude	<ul style="list-style-type: none"> ● Operating altitude: ≤ 3,050 m (10006.44 ft) <p>NOTE</p> <p>When the server is used at an altitude between 900 m (2952.76 ft) and 3050 m (10006.44 ft), the maximum operating temperature decreases by 1°C (1.8°F) for every increase of 300 m (984.25 ft).</p> <ul style="list-style-type: none"> ● HDDs are not supported when the altitude is higher than 3,050 m (10006.44 ft). ● Titanium PSUs are required when the altitude is higher than 3,050 m (10006.44 ft).
Vibration	<p>One cyclical sweep in each axial direction at the rate of 0.1 oct/min, with a total of three axial directions</p> <p>5 Hz to 10 Hz: 5 mm (0.20 in., peak-to-peak value)</p> <p>10 Hz to 100 Hz: 1 m/s²</p>

Item	Specifications
Shock	Half sine wave, peak acceleration of 2 G, 11 ms, 3 times for each surface, and a total of three axial directions
Acoustic noise	<p>The following data is the declared A-weighted sound power levels (LWAd) and declared average bystander position A-weighted sound pressure levels (LpAm) when the server is operating at 23°C (73.4°F). Noise emissions are measured in accordance with ISO 7999 (ECMA 74) and declared in accordance with ISO 9296 (ECMA 109).</p> <p>Idle:</p> <ul style="list-style-type: none"> ● LWAd: 7.4 Bels ● LpAm: 57 dBA <p>Operating:</p> <ul style="list-style-type: none"> ● LWAd: 7.7 Bels ● LpAm: 60 dBA <p>NOTE The actual sound levels generated when the server is operating vary depending on the server configuration, workload, and ambient temperature.</p>
Corrosive gaseous contaminant	<ul style="list-style-type: none"> ● Copper corrosion rate test requirements: The corrosion product thickness growth rate is lower than 300 Å/month (meeting level G1 requirements of the ANSI/ISA-71.04-2013 standard on gaseous corrosion). ● Silver corrosion rate test requirements: The corrosion product thickness growth rate is lower than 200 Å/month.
Particulate pollutant	<ul style="list-style-type: none"> ● The equipment room environment meets the requirements of ISO 14664-1 Class 8. You are advised to ask a professional organization to monitor particulate pollutants in the equipment room. ● There is no explosive, conductive, magnetic, or corrosive dust in the equipment room.
Power Consumption	The power consumption parameters vary with server configurations. For details about how to calculate the power consumption, contact technical support.

 NOTE

SSDs and HDDs (including NL-SAS, SAS, and SATA) cannot be preserved for a long time in the power-off state. Data may be lost or faults may occur if the preservation duration exceeds the specified maximum duration. When drives are preserved under the storage temperature and humidity specified in the preceding table, the following preservation time is recommended:

- Maximum preservation duration of SSDs:
 - 12 months in power-off state without data stored
 - 3 months in power-off state with data stored
- Maximum preservation duration of HDDs:
 - 6 months in unpacked/packed and powered-off state
- The maximum preservation duration is determined according to the specifications provided of drive vendors. For details, see the manuals provided by drive vendors.

Table 6-5 Maximum temperatures supported by the server configured with a RAID controller card supercapacitor

Hard Disk Backplane	Disk Quantity (Q)	CPU Power	Maximum Temperature
X6000 enhanced chassis with 24*2.5-inch NVMe backplane	16 < Q ≤ 24	165 W < P ≤ 205 W: not supported	N/A
		P ≤ 165 W	30°C (86°F)
	8 < Q ≤ 16	165 W < P ≤ 205 W: not supported	N/A
		125 W ≤ P ≤ 165 W	30°C (86°F)
		P < 125 W	35°C (95°F)
	0 < Q ≤ 8: The NVMe backplane is not supported.	N/A	N/A
	X6000 enhanced chassis with 24*2.5-inch SAS backplane	16 < Q ≤ 24	165 W < P ≤ 205 W: not supported
125 W ≤ P ≤ 165 W			32°C (89.6°F)
P < 125 W			35°C (95°F)
8 < Q ≤ 16		165 W < P ≤ 205 W	30°C (86°F)
		140 W ≤ P ≤ 165 W	32°C (89.6°F)
		P < 140 W	35°C (95°F)
0 < Q ≤ 8		165 W < P ≤ 205 W	32°C (89.6°F)

Hard Disk Backplane	Disk Quantity (Q)	CPU Power	Maximum Temperature
		$P \leq 165 \text{ W}$	35°C (95°F)
X6000 enhanced chassis with 12*3.5-inch SAS backplane	$8 < Q \leq 12$	$165 \text{ W} < P \leq 205 \text{ W}$: not supported	N/A
		$125 \text{ W} \leq P \leq 165 \text{ W}$	32°C (89.6°F)
		$P < 125 \text{ W}$	35°C (95°F)
	$4 < Q \leq 8$	$165 \text{ W} < P \leq 205 \text{ W}$	30°C (86°F)
		$140 \text{ W} \leq P \leq 165 \text{ W}$	32°C (89.6°F)
		$P < 140 \text{ W}$	35°C (95°F)
	$0 < Q \leq 4$	$165 \text{ W} < P \leq 205 \text{ W}$	32°C (89.6°F)
		$P \leq 165 \text{ W}$	35°C (95°F)
NOTE For configurations not listed in the table, the temperature range must be 5°C to 30°C (41°F to 86°F). If you need special configurations and temperature requirements, contact the technical support.			

Table 6-6 Maximum temperatures supported by the server configured with an onboard or PCIe optical module

Hard Disk Backplane	Disk Quantity (Q)	CPU Power	Maximum Temperature (With an Onboard Optical Module)	Maximum Temperature (With a PCIe Optical Module)
X6000 enhanced chassis with 24*2.5-inch NVMe backplane	$16 < Q \leq 24$	$165 \text{ W} < P \leq 205 \text{ W}$: not supported	N/A	N/A
		$140 \text{ W} < P \leq 165 \text{ W}$	30°C (86°F)	30°C (86°F)
		$125 \text{ W} < P \leq 140 \text{ W}$	35°C (95°F)	30°C (86°F)
		$P \leq 125 \text{ W}$	35°C (95°F)	35°C (95°F)

Hard Disk Backplane	Disk Quantity (Q)	CPU Power	Maximum Temperature (With an Onboard Optical Module)	Maximum Temperature (With a PCIe Optical Module)
	8 < Q ≤ 16	165 W < P ≤ 205 W: not supported	N/A	N/A
		140 W < P ≤ 165 W	30°C (86°F)	30°C (86°F)
		125 W < P ≤ 140 W	35°C (95°F)	30°C (86°F)
		P ≤ 125 W	35°C (95°F)	35°C (95°F)
	0 < Q ≤ 8	165 W < P ≤ 205 W	30°C (86°F)	30°C (86°F)
		140 W < P ≤ 165 W	35°C (95°F)	30°C (86°F)
		P ≤ 140 W	35°C (95°F)	35°C (95°F)
X6000 enhanced chassis with 24*2.5-inch SAS backplane	16 < Q ≤ 24	165 W < P ≤ 205 W: not supported	N/A	N/A
		140 W < P ≤ 165 W	35°C (95°F)	30°C (86°F)
		P ≤ 140 W	35°C (95°F)	30°C (86°F) For 10GE optical module: 35°C (95°F)
	8 < Q ≤ 16	165 W < P ≤ 205 W	30°C (86°F)	30°C (86°F)
		140 W < P ≤ 165 W	35°C (95°F)	30°C (86°F)
		P ≤ 140 W	35°C (95°F)	35°C (95°F)
	0 < Q ≤ 8	165 W < P ≤ 205 W	35°C (95°F)	30°C (86°F)
		P ≤ 165 W	35°C (95°F)	35°C (95°F)

Hard Disk Backplane	Disk Quantity (Q)	CPU Power	Maximum Temperature (With an Onboard Optical Module)	Maximum Temperature (With a PCIe Optical Module)	
X6000 enhanced chassis with 12*3.5-inch SAS backplane	8 < Q ≤ 12	165 W < P ≤ 205 W: not supported	N/A	N/A	
		140 W < P ≤ 165 W	35°C (95°F)	30°C (86°F)	
		P ≤ 140 W	35°C (95°F)	30°C (86°F) 10GE optical module: 35°C (95°F)	
	4 < Q ≤ 8	165 W < P ≤ 205 W	30°C (86°F)	30°C (86°F)	
		140 W < P ≤ 165 W	35°C (95°F)	30°C (86°F)	
		P ≤ 140 W	35°C (95°F)	35°C (95°F)	
	0 < Q ≤ 4	165 W < P ≤ 205 W	35°C (95°F)	30°C (86°F)	
		P ≤ 165 W	35°C (95°F)	35°C (95°F)	
	NOTE For configurations not listed in the table, the temperature range must be 5°C to 30°C (41°F to 86°F). If you need special configurations and temperature requirements, contact the technical support.				

Table 6-7 Maximum temperatures supported by the server configured with a 240G M.2 RAID controller card

Hard Disk Backplane	Disk Quantity (Q)	CPU Power	Maximum Temperature
X6000 enhanced chassis with 24*2.5-inch NVMe	16 < Q ≤ 24	165 W < P ≤ 205 W: not supported	N/A
		140 W < P ≤ 165 W	30°C (86°F)
		P ≤ 140 W	35°C (95°F)

Hard Disk Backplane	Disk Quantity (Q)	CPU Power	Maximum Temperature	
backplane	8 < Q ≤ 16	165 W < P ≤ 205 W: not supported	N/A	
		140 W < P ≤ 165 W	32°C (89.6°F)	
		P ≤ 140 W	35°C (95°F)	
	0 < Q ≤ 8	165 W < P ≤ 205 W	28°C (82.4°F)	
		P ≤ 165 W	35°C (95°F)	
X6000 enhanced chassis with 24*2.5-inch SAS backplane	16 < Q ≤ 24	165 W < P ≤ 205 W: not supported	N/A	
		140 W < P ≤ 165 W	30°C (86°F)	
		P ≤ 140 W	35°C (95°F)	
	8 < Q ≤ 16	165 W < P ≤ 205 W	28°C (82.4°F)	
		P ≤ 165 W	35°C (95°F)	
	0 < Q ≤ 8	165 W < P ≤ 205 W	32°C (89.6°F)	
		P ≤ 165 W	35°C (95°F)	
	X6000 enhanced chassis with 12*3.5-inch SAS backplane	8 < Q ≤ 12	165 W < P ≤ 205 W: not supported	N/A
			140 W < P ≤ 165 W	30°C (86°F)
P ≤ 140 W			35°C (95°F)	
4 < Q ≤ 8		165 W < P ≤ 205 W	30°C (86°F)	
		140 W < P ≤ 165 W	35°C (95°F)	
0 < Q ≤ 4		P ≤ 205 W	35°C (95°F)	
NOTE For configurations not listed in the table, the temperature range must be 5°C to 30°C (41°F to 86°F). If you need special configurations and temperature requirements, contact the technical support.				

Table 6-8 describe the heat dissipation requirements of X6000 CPUs of different models.

Table 6-8 Heat dissipation requirements of the server configured with CPUs of different models

Drive Backplane	Processor Model	Heat Sink	Drive and Memory Configuration	Max. Air Inlet Temperature
X6000 enhanced chassis with 24 x 2.5" NVMe backplane	Intel® Xeon® Scalable (Skylake and Cascade Lake) processor (165 W < P ≤ 205 W)	Wide conjoined heat sinks	<ul style="list-style-type: none"> • 0 < drives ≤ 8 • DIMMs ≤ 12 	30°C (86°F)
	Intel® Xeon® Scalable (Skylake and Cascade Lake) processor (P ≤ 165 W)	Narrow conjoined heat sinks	<ul style="list-style-type: none"> • Drives ≤ 24 • DIMMs ≤ 16 	35°C (95°F)
		Wide conjoined heat sinks ^a	<ul style="list-style-type: none"> • 0 < drives ≤ 8 • DIMMs ≤ 12 	30°C (86°F)
X6000 enhanced chassis with 24 x 2.5" SAS backplane	Intel® Xeon® Scalable (Skylake and Cascade Lake) processor (165 W < P ≤ 205 W)	Wide conjoined heat sinks	<ul style="list-style-type: none"> • 8 < drives ≤ 16 • DIMMs ≤ 12 	30°C (86°F)
			<ul style="list-style-type: none"> • 0 < drives ≤ 8 • DIMMs ≤ 12 	35°C (95°F)
	Intel® Xeon® Scalable (Skylake and Cascade Lake) processor (P ≤ 165 W)	Narrow conjoined heat sinks	<ul style="list-style-type: none"> • Drives ≤ 24 • DIMMs ≤ 16 	35°C (95°F)
			Wide conjoined heat sinks ^a	<ul style="list-style-type: none"> • 8 < drives ≤ 16 • DIMMs ≤ 12
				<ul style="list-style-type: none"> • 0 < drives ≤ 8 • DIMMs ≤ 12

Drive Backplane	Processor Model	Heat Sink	Drive and Memory Configuration	Max. Air Inlet Temperature
X6000 enhanced chassis with 12 x 3.5" SAS backplane	Intel® Xeon® Scalable (Skylake and Cascade Lake) processor (165 W < P ≤ 205 W)	Wide conjoined heat sinks	<ul style="list-style-type: none"> • 4 < drives ≤ 8 • DIMMs ≤ 12 	30°C (86°F)
			<ul style="list-style-type: none"> • 0 < drives ≤ 4 • DIMMs ≤ 12 	35°C (95°F)
	Intel® Xeon® Scalable (Skylake and Cascade Lake) processor (P ≤ 165 W)	Narrow conjoined heat sinks	<ul style="list-style-type: none"> • Drives ≤ 12 • DIMMs ≤ 16 	35°C (95°F)
			Wide conjoined heat sinks ^a	<ul style="list-style-type: none"> • 4 < drives ≤ 8 • DIMMs ≤ 12
		<ul style="list-style-type: none"> • 0 < drives ≤ 4 • DIMMs ≤ 12 		35°C (95°F)
		<ul style="list-style-type: none"> • a: When Intel® Xeon® Scalable (Gold 6144, Gold 6146, Gold 6244, or Gold 6252N) processors are configured, wide conjoined heat sinks are required to meet the high heat dissipation requirement. 		

Table 6-9 Maximum temperatures supported by the server configured with a CX6 IB card (Part No. 06030437)

Hard Disk Backplane	Disk Quantity (Q)	CPU Power	Maximum Temperature	Remarks
X6000 enhanced chassis with 24 SAS backplane	0 < Q ≤ 8	P ≤ 150 W	30°C (86°F)	Only one CX6 IB card (Part No. 06030437) is supported, which must be installed in slot 1.

Hard Disk Backplane	Disk Quantity (Q)	CPU Power	Maximum Temperature	Remarks
		150 W < P ≤ 250 W	30°C (86°F)	<ul style="list-style-type: none"> Only one CX6 IB card (Part No. 06030437) is supported, which must be installed in slot 1. Servers cannot be stacked. At least 1 U space must be reserved.
<p>NOTE The X6000 standard chassis, X6000 enhanced chassis with 24 NVMe backplane, and X6000 enhanced chassis with 12*3.5-inch SAS backplane do not support this card.</p>				

Table 6-10 describes the environment and air intake requirements of the X6000 chassis .

Table 6-10 X6000 environment and air intake requirements

Server Power	Environment and Air Intake Requirements
2000 W to 3000 W	<ul style="list-style-type: none"> Intel temperature: 35°C (95°F) Wind speed for a server: ≥ 300 CFM Cooling capacity for a server: ≥ 3000 W
< 2000 W	<ul style="list-style-type: none"> Intel temperature: 35°C (95°F) Wind speed for a server: ≥ 200 CFM Cooling capacity for a server: ≥ 2000 W

6.2 Standard Chassis

6.2.1 Chassis Specifications

Chassis Specifications

Table 6-11 lists the X6000 technical specifications.

Table 6-11 X6000 technical specifications

Item	Description
Form factor	2U multi-node server
Server nodes	2U high with 4 nodes

Item	Description
Management ports	<ul style="list-style-type: none"> ● One aggregation network port to allow unified chassis management. ● One management network port on each node.
PSUs	<p>Supported PSUs:</p> <ul style="list-style-type: none"> ● 2 x 1500 W AC PSUs (compatible with 240 HVDC) ● 2 x enhanced 1500 W AC PSUs (compatible with 240 HVDC) ● 2 x 2000 W AC PSUs (compatible with 240 HVDC) ● 2 x 1200 W DC PSUs <p>NOTE</p> <ul style="list-style-type: none"> ● The X6000 standard chassis PSUs support 1+1 redundancy mode only when the server power consumption is lower than that of a single server. ● If the input power is between 100 V and 120 V, the working power of 1500 W PSUs decreases to 1000 W. ● If the input power is between 100 V and 127 V, the working power of enhanced 1500 W PSUs decreases to 1000 W. ● If the input power is between 200 V and 240 V, or 240 V HVDC, the working power of 1500 W PSUs is 1500 W. ● If the input power is between 200 V and 240 V, or 240 V HVDC, the working power of enhanced 1500 W PSUs is 1700 W. ● If the input power is between 200 V and 220 V, the working power of 2000 W PSUs is 1800 W. ● If the input power is between 220 V and 240 V, or 240 V HVDC, the working power of 2000 W PSUs is 2000 W. ● If the input power is between -48 V and -60 V, the working power of 1200 W DC PSUs is 1200 W.
Fan modules	Four fan modules in N+1 redundancy mode

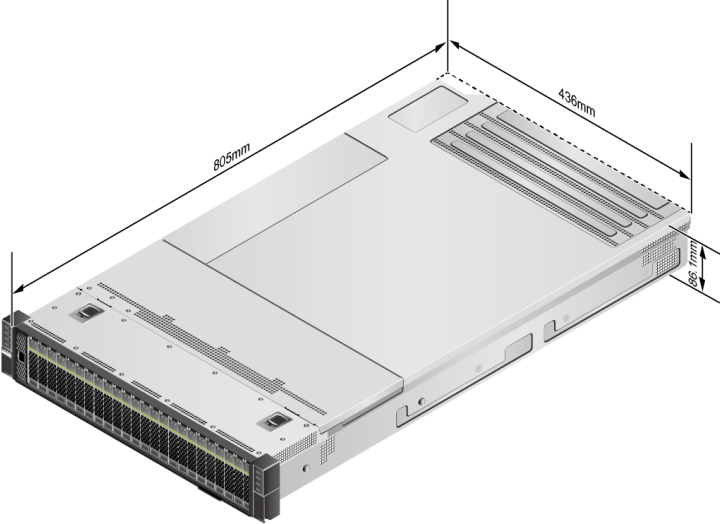
Item	Description
Dimensions (H x W x D)	<p data-bbox="651 293 1425 327">86.1 mm x 436 mm x 805 mm (3.39 in. x 17.17 in. x 31.69 in.)</p> <p data-bbox="651 371 1050 405">Figure 6-2 Physical dimensions</p>  <p data-bbox="651 994 719 1016">NOTE</p> <ul data-bbox="676 1034 1410 1167" style="list-style-type: none"> • The depth includes the mounting ear size. • The minimum cabinet depth is 1 m (3.28 ft.). • See Figure 6-2 for methods in measuring physical dimensions of the chassis.
Weight	<ul data-bbox="651 1193 1098 1267" style="list-style-type: none"> • Server weight: 36 kg (79.38 lb) • Packing weight: 5.5 kg (12.13 lb)

6.2.2 Node Specifications

The X6000 holds XH321 V5 server node. [Table 6-12](#) describes server node specifications.

Table 6-12 Server node specifications

Type	Model	Specifications
Chassis	X6000	2U chassis with node slots

Type	Model	Specifications
Server node	XH321 V5	Optional configuration: <ul style="list-style-type: none"> • One or two Intel® Xeon® Scalable 3100, 4100, 5100, 6100, or 8100 series processors • A maximum of sixteen DDR4 DIMMs • Six 2.5-inch SAS/SATA hard disks or NVMe SSDs • One TPM • Two M.2 SATA SSD cards • Two half-height half-length standard PCIe cards (standard PCIe card slot 1 available for a RAID controller card)

 NOTE

The maximum I/O bandwidth of XH321 V5 hard disks managed through the southbridge is 1.9 GB/s due to the bandwidth limit of the SATA controller integrated in the southbridge.

6.2.3 Power Specifications

The X6000 provides two slots for installing PSUs. [Table 6-13](#) lists power specifications.

Table 6-13 Power specifications

PSU Type	Power Rating	Power Output	Input Voltage	Maximum Input Current per PSU	Output Voltage
2000 W PSU	2000 W	2000 W	220 V AC to 240 V AC at 50 Hz or 60 Hz	10 A	12 V
			240 V DC	10 A	
		1800 W	200 V AC to 220 V AC at 50 Hz or 60 Hz	10 A	
1500 W PSU	1500 W	1500 W	200 V AC to 240 V AC at 50 Hz or 60 Hz	10 A	12 V
			240 V DC	8 A	
		1000 W	100 V AC to 120 V AC at 50 Hz or 60 Hz	12.5 A	

PSU Type	Power Rating	Power Output	Input Voltage	Maximum Input Current per PSU	Output Voltage
Enhanced 1500 W PSU	1500 W	1700 W	200 V AC to 240 V AC at 50 Hz or 60 Hz	10 A	
			240 V DC	8 A	
		1000 W	100 V AC to 127 V AC at 50 Hz or 60 Hz	12.5 A	
1200 W PSU	1200 W	1200 W	-48 V DC to -60 V DC	32 A	

 **NOTE**

- For details about PSU models, use the [Compatibility Checker](#).
- When two enhanced 1500 W PSUs (BOM code: 02131336 or 02312DAE) are configured, each can provide a loading capability of up to 1700 W and function as a 1700 W PSU.

6.2.4 Environmental Specifications

[Table 6-14](#) describes the X6000 environmental specifications.

Table 6-14 X6000 environmental specifications

Item	Description
Temperature	Operating temperature: 5°C to 35°C (41°F to 95°F) Non-operating temperature: -40°C to +65°C (-40°F to +149°F) NOTE XH321 V5: <ul style="list-style-type: none"> • If a single fan fails, the server node supports the operating temperature ranging from 5°C to 30°C (41°F to 86°F). • If the server node is configured with processors of 125 W or above, the failure of a single fan may affect the server node performance or cause overheating alarms. Replacing the faulty fan can resolve the issues caused by the fan failure. • For the temperature specifications of the server node configured with a RAID controller card supercapacitor and optical modules, see Table 6-15, Table 6-16, and Table 6-17.
Relative humidity (non-condensing)	Operating humidity: 8% to 90% RH Storage humidity: 5% to 95% RH

Item	Description
Maximum temperature fluctuation rate	< 20°C/h (68°F/h)
Altitude	<ul style="list-style-type: none"> ● Operating altitude ≤ 3050 m (10006.44 ft) <p>NOTE When the server is used at an altitude from 900 m (2952.76 ft) to 3050 m (10006.44 ft), the highest operating temperature decreases by 1°C (1.8°F) for every increase of 300 m (984.25 ft).</p> <ul style="list-style-type: none"> ● At an altitude of over 3050 m (10006.44 ft), only Titanium PSUs can be used. ● HDDs are not supported at an altitude of over 3050 m (10006.44 ft).
Vibration	One cyclical sweep in each axial direction at the rate of 0.1 oct/min, with a total of three axial directions 5 Hz to 10 Hz: 5 mm (0.20 in., peak-to-peak value) 10 Hz to 100 Hz: 1 m/s ²
Shock	Half sine wave, peak acceleration of 2 G, 11 ms, 100 times for each surface, and a total of three axial directions
Acoustic noise	The data listed in the following is the declared A-weighted sound power levels (LWAd) and declared average bystander position A-weighted sound pressure levels (LpAm) when the server is operating at 23°C (73.4°F). Noise emissions are measured in accordance with ISO 7999 (ECMA 74) and declared in accordance with ISO 9296 (ECMA 109). XH321 V5: Idle: <ul style="list-style-type: none"> ● LWAd: 7.4 Bels ● LpAm: 57 dBA Operating: <ul style="list-style-type: none"> ● LWAd: 7.7 Bels ● LpAm: 60 dBA <p>NOTE The actual sound levels generated when the server is operating vary depending on the server configuration, workload, and ambient temperature.</p>

Item	Description
Input voltage	<ul style="list-style-type: none"> ● 2000 W PSU: <ul style="list-style-type: none"> – 200 V to 220 V AC, 50Hz/60Hz – 220 V to 240 V AC, 50Hz/60Hz – 240 V DC ● 1500 W PSU: <ul style="list-style-type: none"> – 100 V to 120 V AC, 50Hz/60Hz – 200 V to 240 V AC, 50Hz/60Hz – 240 V DC ● Enhanced 1500 W PSU: <ul style="list-style-type: none"> – 100 V to 127 V AC, 50Hz/60Hz – 200 V to 240 V AC, 50Hz/60Hz – 240 V DC ● 1200 W PSU: <ul style="list-style-type: none"> – -48 V to -60 V DC
Rated power	The rated power for compatible PSUs: <ul style="list-style-type: none"> ● 220 V to 240 V AC or 240 V DC: 2000 W ● 200 V to 240 V AC or 240 V DC: 1500 W ● -48 V to -60 V DC: 1200 W
Corrosive air pollutant	<ul style="list-style-type: none"> ● Corrosion rate of the copper test piece: < 300 Å/month (in compliance with the ANSI/ISA-71.04-2013 gaseous corrosion level G1). ● Corrosion rate of the silver test piece: < 200 Å/month.
Particulate pollutant	<ul style="list-style-type: none"> ● The ISO14664-1 Class 8 requirements are met. You are advised to ask a professional organization to monitor particulate pollutants in the equipment room. ● There is no explosive, conductive, magnetic, or corrosive dust in the equipment room.
Power consumption	The power consumption parameters vary with server configurations. For details about how to calculate the power consumption, contact technical support.

Table 6-15 Maximum temperatures supported by the server configured with a RAID controller card supercapacitor

Hard Disk Backplane	Disk Quantity (Q)	CPU Power	Maximum Temperature
X6000 standard chassis with 24*2.5-inch NVMe backplane	16 < Q ≤ 24	P ≤ 165 W	30°C (86°F)
	8 < Q ≤ 16	125 W ≤ P ≤ 165 W	30°C (86°F)
		P < 125 W	35°C (95°F)
X6000 standard chassis with 24*2.5-inch SAS backplane	16 < Q ≤ 24	125 W ≤ P ≤ 165 W	32°C (89.6°F)
		P < 125 W	35°C (95°F)
	8 < Q ≤ 16	140 W ≤ P ≤ 165 W	32°C (89.6°F)
		P < 140 W	35°C (95°F)
	0 < Q ≤ 8	P ≤ 165 W	35°C (95°F)
<p>NOTE For configurations not listed in the table, the temperature range must be 5°C to 30°C (41°F to 86°F). If you need special configurations and temperature requirements, contact the technical support.</p>			

Table 6-16 Maximum temperatures supported by the server configured with an onboard or PCIe optical module

Hard Disk Backplane	Disk Quantity (Q)	CPU Power	Maximum Temperature (With an Onboard Optical Module)	Maximum Temperature (With a PCIe Optical Module)
X6000 standard chassis with 24*2.5-inch NVMe backplane	16 < Q ≤ 24	140 W < P ≤ 165 W	30°C (86°F)	30°C (86°F)
		125 W < P ≤ 140 W	35°C (95°F)	30°C (86°F)
		P ≤ 125 W	35°C (95°F)	35°C (95°F)
	8 < Q ≤ 16	140 W < P ≤ 165 W	30°C (86°F)	30°C (86°F)
		125 W < P ≤ 140 W	35°C (95°F)	30°C (86°F)
		P ≤ 125 W	35°C (95°F)	35°C (95°F)

Hard Disk Backplane	Disk Quantity (Q)	CPU Power	Maximum Temperature (With an Onboard Optical Module)	Maximum Temperature (With a PCIe Optical Module)
	0 < Q ≤ 8	140 W < P ≤ 165 W	35°C (95°F)	30°C (86°F)
		P ≤ 140 W	35°C (95°F)	35°C (95°F)
X6000 standard chassis with 24*2.5-inch SAS backplane	16 < Q ≤ 24	140 W < P ≤ 165 W	35°C (95°F)	30°C (86°F)
		P ≤ 140 W	35°C (95°F)	30°C (86°F) 10GE optical module: 35°C (95°F)
	8 < Q ≤ 16	140 W < P ≤ 165 W	35°C (95°F)	30°C (86°F)
		P ≤ 140 W	35°C (95°F)	35°C (95°F)
	0 < Q ≤ 8	P ≤ 165 W	35°C (95°F)	35°C (95°F)

NOTE
 For configurations not listed in the table, the temperature range must be 5°C to 30°C (41°F to 86°F). If you need special configurations and temperature requirements, contact the technical support.

Table 6-17 Maximum temperatures supported by the server configured with a 240G M.2 RAID controller card

Hard Disk Backplane	Disk Quantity (Q)	CPU Power	Maximum Temperature
X6000 standard chassis with 24*2.5-inch NVMe backplane	16 < Q ≤ 24	140 W < P ≤ 165 W	28°C (82.4°F)
		P ≤ 140 W	32°C (89.6°F)
	8 < Q ≤ 16	140 W < P ≤ 165 W	30°C (86°F)
		P ≤ 140 W	35°C (95°F)
	0 < Q ≤ 8	140 W < P ≤ 165 W	35°C (95°F)
		P ≤ 140 W	35°C (95°F)
X6000 standard chassis	16 < Q ≤ 24	140 W < P ≤ 165 W	30°C (86°F)
		P ≤ 140 W	35°C (95°F)

Hard Disk Backplane	Disk Quantity (Q)	CPU Power	Maximum Temperature
with 24*2.5-inch SAS backplane	8 < Q ≤ 16	140 W < P ≤ 165 W	32°C (89.6°F)
		P ≤ 140 W	35°C (95°F)
	0 < Q ≤ 8	P ≤ 165 W	35°C (95°F)
NOTE For configurations not listed in the table, the temperature range must be 5°C to 30°C (41°F to 86°F). If you need special configurations and temperature requirements, contact the technical support.			

Table 6-18 describe the heat dissipation requirements of X6000 CPUs of different models.

Table 6-18 Heat dissipation requirements of the server configured with CPUs of different models

Drive Backplane	Processor Model	Heat Sink	Drive and Memory Configuration	Max. Air Inlet Temperature
X6000 standard chassis with 24 x 2.5" SAS backplane	Intel® Xeon® Scalable (Skylake and Cascade Lake) processor (P ≤ 165 W) ^a	Narrow conjoined heat sinks	<ul style="list-style-type: none"> • Drives ≤ 24 • DIMMs ≤ 16 	35°C (95°F)
X6000 standard chassis with 24 x 2.5 NVMe backplane	Intel® Xeon® Scalable (Skylake and Cascade Lake) processor (P ≤ 165 W) ^a	Narrow conjoined heat sinks	<ul style="list-style-type: none"> • Drives ≤ 24 • DIMMs ≤ 16 	35°C (95°F)
a: The standard chassis does not support Intel® Xeon® Scalable (Gold 6144, Gold 6146, Gold 6244, and Gold 6252N) processors.				

 **NOTE**

Contact technical support for specific CPU models.

7 Warranty and Safety

[7.1 Warranty](#)

[7.2 Safety](#)

7.1 Warranty

For details about the maintenance policy, visit [Customer Support Service](#).

For details about the warranty policy, visit [Warranty](#).

7.2 Safety

For details, see [Server Safety Information](#).

8 Waste Product Recycling

If product users need product recycling service provided by xFusion after products are scrapped, contact technical support for services.

A Appendix

A.1 Chassis Label

 NOTE

The label information and location are for reference only. For details, see the actual product.

A.1.1 Chassis Head Label

Figure A-1 Chassis head label

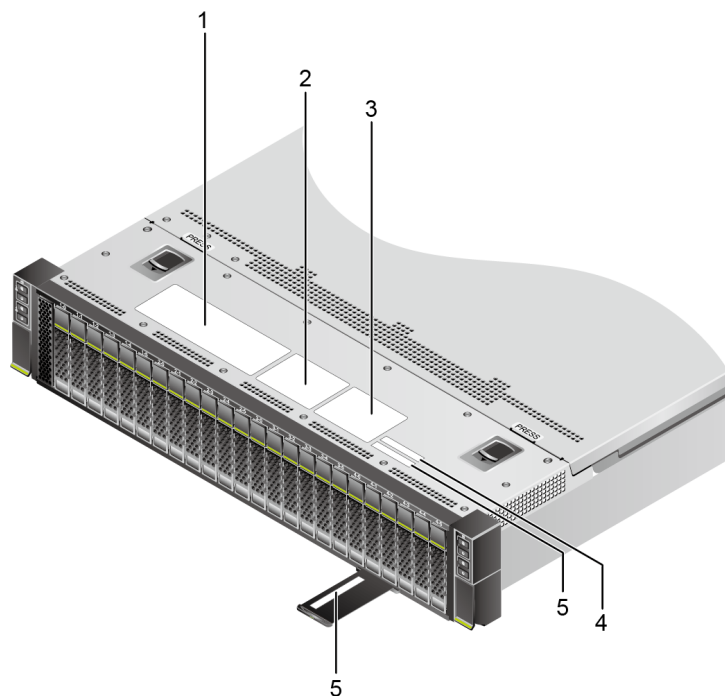

1	Nameplate	2	Certificate
---	-----------	---	-------------

3	Quick access tag	4	Reserved space for custom label
5	SN NOTE For details, see A.1.1.1 Product SN .	-	-

A.1.1.1 Product SN

The serial number (SN) on the slide-out label plate uniquely identifies a device. The SN is required when you contact technical support.

Figure A-2 Example SN



Table A-1 SN description

No.	Description
1	ESN ID (two characters), which can only be 21 .
2	Material ID (eight characters), that is, the processing code.
3	Vendor code (two characters), that is, the code of the processing place.
4	Year and month (two characters). <ul style="list-style-type: none"> The first character indicates the year. <ul style="list-style-type: none"> Digits 1 to 9 indicate years 2001 to 2009, respectively. Letters A to H indicate years 2010 to 2017, respectively. Letters J to N indicate years 2018 to 2022, respectively. Letters P to Y indicate years 2023 to 2032, respectively. NOTE The years from 2010 are represented by upper-case letters excluding I, O, and Z because the three letters are similar to the digits 1, 0, and 2. The second character indicates the month. <ul style="list-style-type: none"> Digits 1 to 9 indicate January to September, respectively. Letters A to C indicate October to December, respectively.
5	Serial number (six digits).
6	RoHS compliance (one character). Y indicates RoHS compliant.

No.	Description
7	Internal model (product name) of the board.

A.1.1.2 Nameplate

Figure A-3 Nameplate example

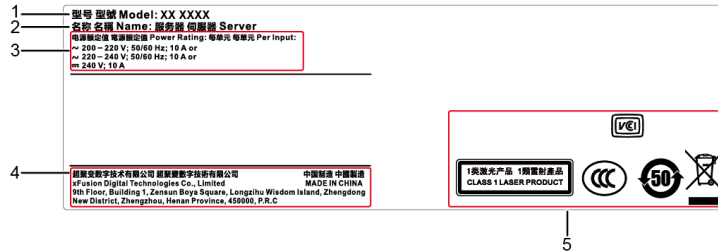

Table A-2 Nameplate description

No.	Description
1	Server Model For details, see Table A-3 .
2	Device names
3	Power Supply Requirements
4	Vendor Information
5	Authentication ID

Table A-3 Nameplate

Certified Model	Usage Restrictions
X6000	Global

A.1.1.3 Certificate

Figure A-4 Sample certificate of conformity



Table A-4 Certificate of conformity description

No.	Description
1	Order
2	No. NOTE For details, see Figure A-5 and Table A-5 .
3	QC inspector
4	Production date
5	No. Barcode

Figure A-5 Sample certificate number

PZY0224SL0B-00019

The figure shows the certificate number PZY0224SL0B-00019 with vertical lines and numbers 1 through 10 positioned below each character to indicate its position. The characters are: 1: P, 2: Z, 3: Y, 4: 0, 5: 2, 6: 2, 7: 4, 8: S, 9: L, 10: 0, followed by a hyphen, then 10: 0, 11: 0, 12: 0, 13: 1, 14: 9.

Table A-5 Certificate No. Description

No.	Description
1	"P", fixed
2	"Z", fixed
3	<ul style="list-style-type: none"> • Y: Server • B: Semi-finished product of the whole machine. • N: Loose spare parts
4	"0", Reserved bit.
5	Year (2 digits).
6	Month (1 digit). <ul style="list-style-type: none"> • Digits 1 to 9 indicate January to September, respectively. • Letters A to C indicate October to December, respectively.
7	Day (1 digit). <ul style="list-style-type: none"> • Digits 1 to 9 indicate the 1st to 9th • Letters A to H indicate the 10th to 17th. • Letters J to N indicate the 18th to 22nd. • Letters P to Y indicate the 23rd to 31st

No.	Description
8	Hour (1 digit). <ul style="list-style-type: none"> • Digits 0 to 9 indicate 0 to 9:00. • Letters A to H indicate 10 to 17:00. • Letters J to N indicate 18 to 22:00. • Letters P to Q indicate 23 to 24:00.

A.1.1.4 Sample Quick Access Tags

Figure A-6 Sample quick access tags

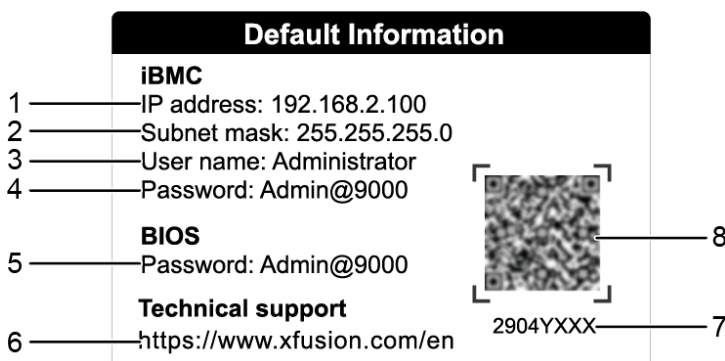
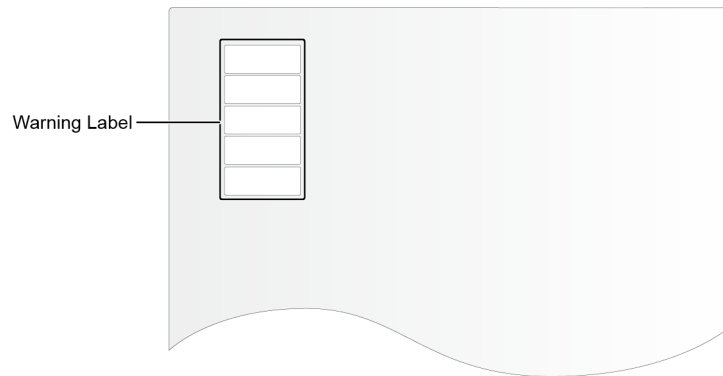

Table A-6 Quick access tab description

No.	Description
1	IP address of the iBMC management network port
2	Subnet mask of the iBMC management network port
3	Default iBMC user name
4	Default iBMC password
5	Default BIOS password
6	Technical support website
7	P/N Code
8	QR Code NOTE Scan the QR code to obtain technical support resources.

A.1.2 Chassis Tail Label

Figure A-7 Chassis tail label



 **NOTE**

For details about the warning label, see [Server Security Information](#).

A.2 Acronyms and Abbreviations

A

AC	Alternating Current
AES NI	Advanced Encryption Standard New Instruction Set
ARP	Address Resolution Protocol
AVX	Advanced Vector Extensions

B

BBU	Backup Battery Unit
------------	---------------------

C

CD	Calendar Day
CIM	Common Information Model
CLI	Command-line Interface

D

DC	Direct Current
DDR3	Double Data Rate 3
DDR4	Double Data Rate 4
DEMT	Dynamic Energy Management Technology
DIMM	Dual In-line Memory Module

DVD	Digital Video Disc
E	
ECC	Error Checking and Correcting
ECMA	European Computer Manufacturers Association
EDB	Execute Disable Bit
EN	European Efficiency
ETS	European Telecommunications Standards
F	
FC	Fiber Channel
FTP	File Transfer Protocol
G	
GE	Gigabit Ethernet
GPIO	General Purpose Input/Output
H	
HDD	Hard Disk Drive
HMM	Hyper Management Module
HPC	High-performance Computing
HTTP	Hypertext Transfer Protocol
HTTPS	Hypertext Transfer Protocol Secure
HVDC	High Voltage Direct Current
I	
ICMP	Internet Control Message Protocol
IDC	Internet Data Center
IEC	International Electrotechnical Commission
IEEE	Institute of Electrical and Electronics Engineers
IGMP	Internet Group Message Protocol
iBMC	Integrated Baseboard Management Controller
IOPS	Input/Output Operations per Second
IP	Internet Protocol
IPC	Intelligent Power Capability

IPMB	Intelligent Platform Management Bus
IPMI	Intelligent Platform Management Interface
K	
KVM	Keyboard Video and Mouse
L	
LC	Lucent Connector
LDIMM	Local Dual In-line Memory Module
LED	Light Emitting Diode
M	
MAC	Media Access Control
N	
NBD	Next Business Day
NC-SI	Network Controller Sideband Interface
P	
PCIe	Peripheral Component Interconnect Express
PHY	Physical Layer
PMBUS	Power Management Bus
POK	Power OK
PWM	Pulse-width Modulation
Q	
QPI	QuickPath Interconnect
R	
RAID	Redundant Array of Independent Disks
RDIMM	Registered Dual In-line Memory Module
RJ45	Registered Jack 45
S	
SAS	Serial Attached Small Computer System Interface
SATA	Serial Advanced Technology Attachment
SGMII	Serial Gigabit Media Independent Interface

SMTP	Simple Mail Transfer Protocol
SM_CLP	Server Management Command Line Protocol
SNMP	Simple Network Management Protocol
SSD	Solid-state Drive
T	
TACH	Tachometer signal
TBT	Turbo Boost Technology
TCG	Trusted Computing Group
TDP	Thermal Design Power
TELNET	Telecommunication Network Protocol
TET	Trusted Execution Technology
TFTP	Trivial File Transfer Protocol
TPM	Trusted Platform Module
U	
UDIMM	Unbuffered Dual In-line Memory Module
UEFI	Unified Extensible Firmware Interface
UID	Unit Identification Light
UL	Underwriter Laboratories Inc.
USB	Universal Serial Bus
V	
VGA	Video Graphics Array
VRD	Voltage Regulator-Down
W	
WSMAN	Web Service Management